



Profilübersichten 2018

profile systems

Legende · Legend



PVC weiß oder farbig durchgefärbt · uPVC white or solid-coloured



foliiert · laminated



PMMA außen farbig, auf PVC Grundkörper · PMMA colour on uPVC



PVC Profil mit Recyclingkern · uPVC profile with recycling core



Statische-Trocken-Verglasung STV · STV static dry glazing



Intensiv-Kern-Dämmung IKD · IKD intensive core insulation

....51

Stahl · steel

....52

Aluminium · aluminium

....55

Zinkdruckguss · zinc diecasting

....70

Kunststoffzubehör · plastics accessories

....80

Polyamid-Zubehör · polyamide accessories

....90

EPDM Dichtung · EPDM gasket

....91

Silikon · silicone

....92

TPE Dichtung · TPE gasket

....93

PVC weich · Flexible PVC

....99

Sonstige Materialien und Fensterzubehör · other materials and window accessories



Profloberfläche mit Dekor- oder Farbfolie · surface laminated with wooden-structure or coloured film



PMMA-Oberfläche coextrudiert · PMMA surface, coextruded

Ix und Iy Werte in cm⁴ · Ix and Iy value in cm⁴



grau angelegte Profile in Vorbereitung · grey profiles in process of realisation

Export: **Nicht im Standardlieferprogramm enthalten**

Hinweis:

Der Inhalt dieser Profilübersicht ist unverbindlich! Das exakte Lieferprogramm entnehmen Sie bitte der aktuellen Übersicht „Profile und Zubehör“.

Please note:

The content of this compendium is not binding! See the exact product range in the summary „Profiles and Accessories“.

S 7000 IQ Blendrahmen · Frames

5-Kammer

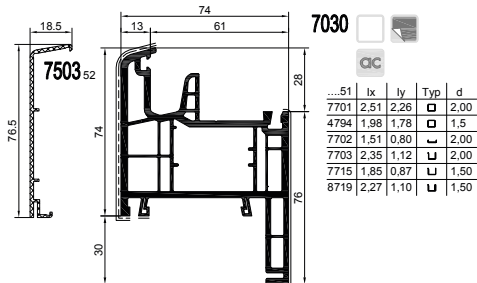
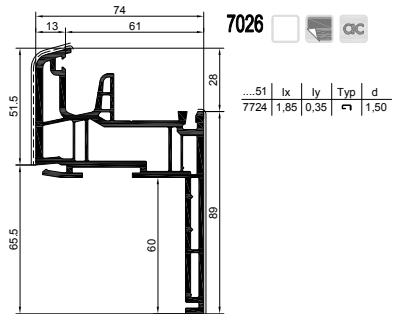
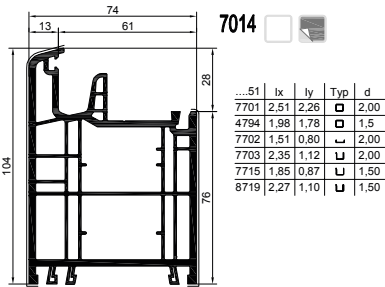
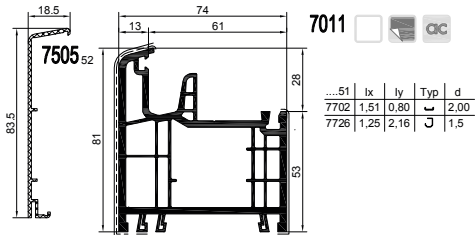
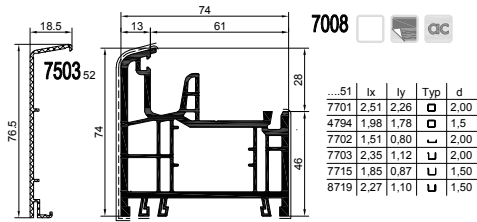

S 7000 IQ plus Blendrahmen · Frames

6-Kammer

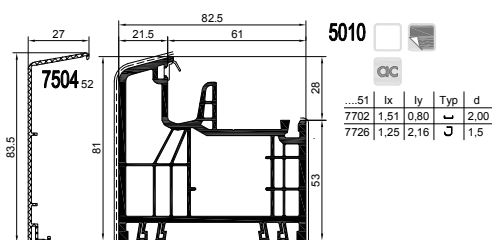
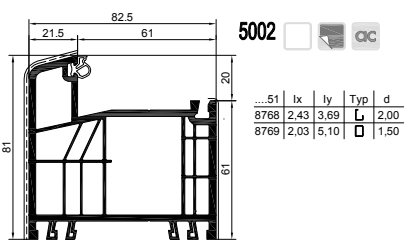

S 7000 IQ
S 7000 IQ plus

S 8000 IQ

S 9000
S 9000 plus

GEALAN-KUBUS®

S 9000 NL

Stulp

Sprossen

Glasleisten

Aussteifungen

Dichtungen

Rahmenverbreiterungen

Kopplungsprofile

Eckprofile

Verleistungen

Untere Anschlussprofile

Laibungsverkleidungen

GEALAN
HAFEN-CITY-FENSTER®

Schwellen

Lüftungssystem

Hebeschiebesysteme

Schiebesysteme

Rollladen

Klappläden

Scuro

Cassonetto

Sonstiges

S 7000 IQ Pfosten · Mullions

- S 7000 IQ
S 7000 IQ plus
- S 8000 IQ
- S 9000
S 9000 plus
- GEALAN-KUBUS®
- S 9000 NL
- Stulp
- Sprossen
- Glasleisten
- Aussteifungen
- Dichtungen
- Rahmenverbreiterungen
- Kopplungsprofile
- Eckprofile
- Verleistungen
- Untere Anschlussprofile
- Laibungsverkleidungen
- GEALAN
HAFEN-CITY-FENSTER®
- Schwellen
- Lüftungssystem
- Hebeschiebesysteme
- Schiebesysteme
- Rollladen
- Klappladen
- Scuro
- Cassonetto
- Sonstiges

3-Kammer

7510 

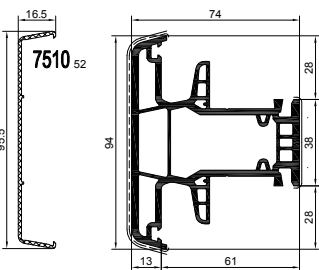

...s1	lx	ly	Typ	d
7705	5,80	1,97		2,00
7719	4,02	1,92		2,00

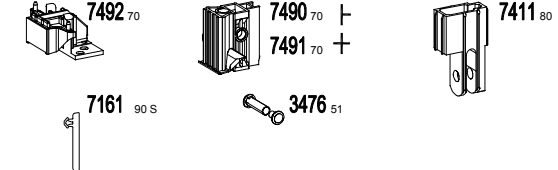

7509 

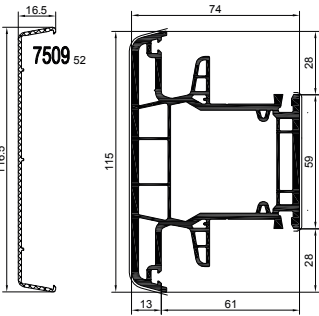

...s1	lx	ly	Typ	d
7722	12,03	11,48		2,50

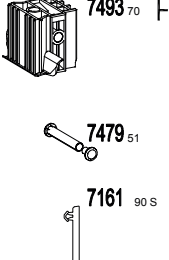

S 7000 IQ plus Pfosten · Mullions

4-Kammer

5404 

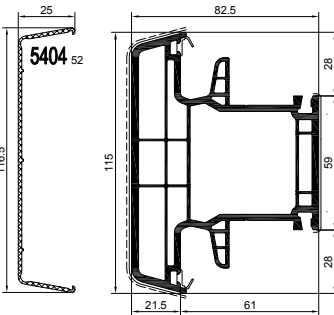

...s1	lx	ly	Typ	d
7722	12,03	11,48		2,50

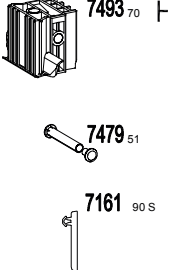

5419 

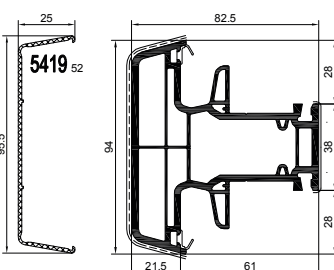

...s1	lx	ly	Typ	d
7705	5,80	1,97		2,00
7719	4,02	1,92		2,00

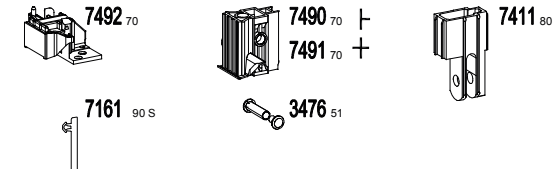

S 7000 IQ Flügel · Sashes

5-Kammer

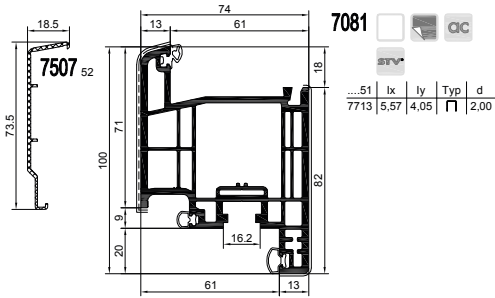
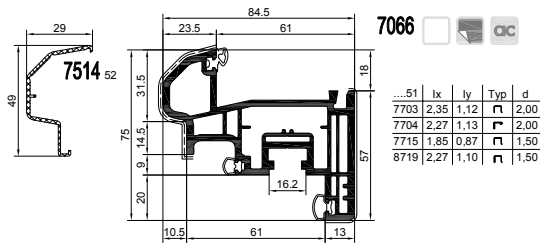
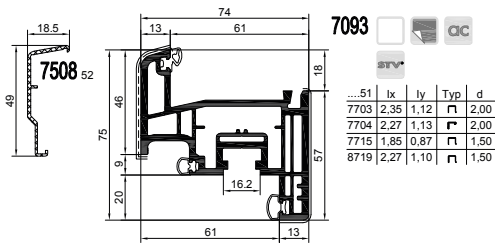

S 7000 IQ plus Flügel · Sashes

6-Kammer

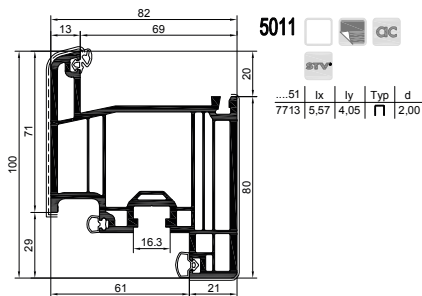
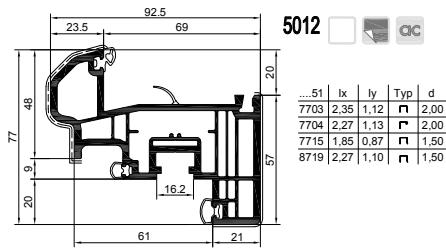
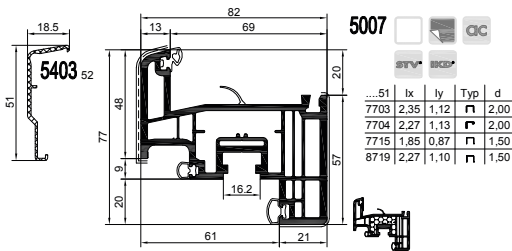

- S 7000 IQ
- S 7000 IQ plus
- S 8000 IQ
- S 9000
- S 9000 plus
- GEALAN-KUBUS*
- S 9000 NL
- Stulp
- Sprossen
- Glasleisten
- Aussteifungen
- Dichtungen
- Rahmenverbreiterungen
- Kopplungsprofile
- Eckprofile
- Verleistungen
- Untere Anschlussprofile
- Laibungsverkleidungen
- GEALAN HAFEN-CITY-FENSTER®
- Schwellen
- Lüftungssystem
- Hebeschiebesysteme
- Schiebesysteme
- Rollladen
- Klappladen
- Scuro
- Cassonetto
- Sonstiges

S 8000 IQ Blendrahmen · Frames

S 7000 IQ
S 7000 IQ plus

S 8000 IQ

S 9000
S 9000 plus

GEALAN-KUBUS®

S 9000 NL

Stulp

Sprossen

Glasleisten

Aussteifungen

Dichtungen

Rahmenverbreiterungen

Kopplungsprofile

Eckprofile

Verleistungen

Untere Anschlussprofile

Laibungsverkleidungen

GEALAN
HAFEN-CITY-FENSTER®

Schwellen

Lüftungssystem

Hebeschiebesysteme

Schiebesysteme

Rollladen

Klappladen

Scuro

Cassonetto

Sonstiges

4-Kammer

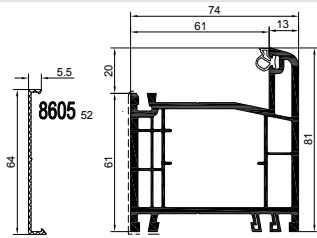

8013

...51	lx	ly	Typ	d
8705	4,78	6,21	□	2,00
8707	3,90	0,43	□	2,00
8714	4,78	5,86	□	1,50

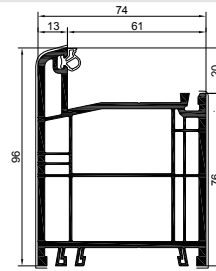

8014

...51	lx	ly	Typ	d
8701	5,92	2,87	□	2,00
8703	5,51	1,80	□	2,00
8751	4,50	2,25	□	1,50
8753	4,27	1,40	□	1,50
8758	3,38	1,52	□	2,00
8794	3,70	2,61	□	2,00

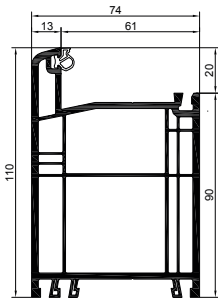

8015

...51	lx	ly	Typ	d
8701	5,92	2,87	□	2,00
8703	5,51	1,80	□	2,00
8705	4,78	6,21	□	2,00
8751	4,50	2,25	□	1,50
8753	4,27	1,40	□	1,50
8758	3,38	1,52	□	2,00
8794	3,70	2,61	□	2,00

5-Kammer

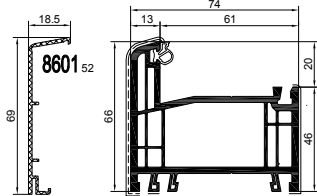

8006

...51	lx	ly	Typ	d
8701	5,92	2,87	□	2,00
8703	5,51	1,80	□	2,00
8751	4,50	2,25	□	1,50
8753	4,27	1,40	□	1,50
8758	3,38	1,52	□	2,00
8794	3,70	2,61	□	2,00

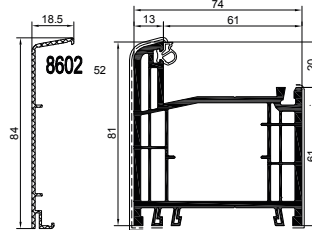

8012

...51	lx	ly	Typ	d
8705	4,78	6,21	□	2,00
8707	3,90	0,43	□	2,00
8714	4,78	5,86	□	1,50

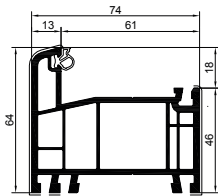

8032

...51	lx	ly	Typ	d
8715	1,90	1,90	□	1,50
8716	1,74	1,05	□	1,50
8727	2,20	1,35	□	2,00
5765	2,38	2,40	□	2,00

6-Kammer

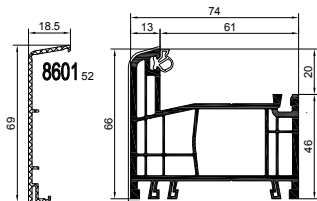

8001

...51	lx	ly	Typ	d
8715	1,90	1,90	□	1,50
8716	1,74	1,05	□	1,50
8727	2,20	1,35	□	2,00
5765	2,38	2,40	□	2,00

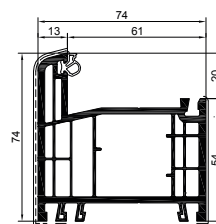

8010

...51	lx	ly	Typ	d
8710	2,65	3,95	□	2,00
8764	1,50	0,31	□	2,00

Monoblock-Blendrahmen

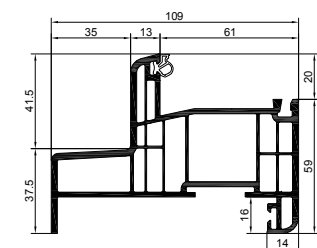

5500

...51	lx	ly	Typ	d
8715	1,90	1,90	□	1,50
8716	1,74	1,05	□	1,50
8727	2,20	1,35	□	2,00
5765	2,38	2,40	□	2,00

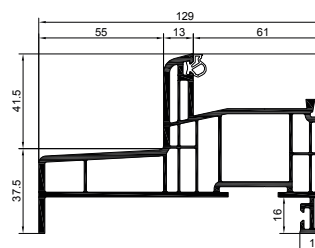

5501

...51	lx	ly	Typ	d
8715	1,90	1,90	□	1,50
8716	1,74	1,05	□	1,50
8727	2,20	1,35	□	2,00
5765	2,38	2,40	□	2,00



S 8000 IQ Blendrahmen · Frames

Monoblock-Blendrahmen

S 7000 IQ
S 7000 IQ plus

S 8000 IQ

S 9000 plus
S 9000 plus

GEALAN-KUBUS®

S 9000 NL

Stulp

Sprossen

Glasleisten

Aussteifungen

Dichtungen

Rahmenverbreiterungen

Kopplungsprofile

Eckprofile

Verleistungen

Untere Anschlussprofile

Laibungsverkleidungen

GEALAN HAFEN-CITY-FENSTER®

Schwellen

Lüftungssystem

Hebeschiebesysteme

Schiebesysteme

Rollladen

Klappladen

Scuro

Cassonetto

Sonstiges

5502 Export

...51	ix	ly	Typ	d
8715	1,90	1,90	□	1,50
8716	1,74	1,05	U	1,50
8727	2,20	1,35	U	2,00
5765	2,38	2,40	□	2,00



5520

5521

5503 Export

...51	ix	ly	Typ	d
8715	1,90	1,90	□	1,50
8716	1,05	1,74	U	1,50
8727	2,20	1,35	U	2,00
5765	2,38	2,40	□	2,00



5517 Export

...51	ix	ly	Typ	d
8715	1,90	1,90	□	1,50
8716	1,05	1,74	U	1,50
8727	2,20	1,35	U	2,00
5765	2,38	2,40	□	2,00

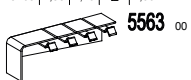

6-Kammer Blendrahmen

8033

...51	ix	ly	Typ	d
8715	1,90	1,90	□	1,50
8716	1,74	1,05	U	1,50
8727	2,20	1,35	U	2,00
5765	2,38	2,40	□	2,00

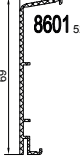

8034

...51	ix	ly	Typ	d
6744	1,24	0,59	□	1,50
6745	1,56	0,73	□	2,00

5505 Export

...51	ix	ly	Typ	d
8715	1,90	1,90	□	1,50
8716	1,74	1,05	U	1,50
8727	2,20	1,35	U	2,00
5765	2,38	2,40	□	2,00

5534 Export

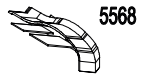

S 8000 IQ Blendrahmen · Frames

S 7000 IQ
S 7000 IQ plus

6-Kammer

S 8000 IQ

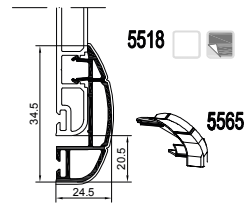
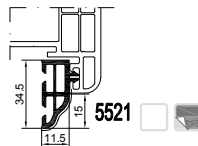
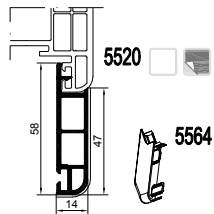
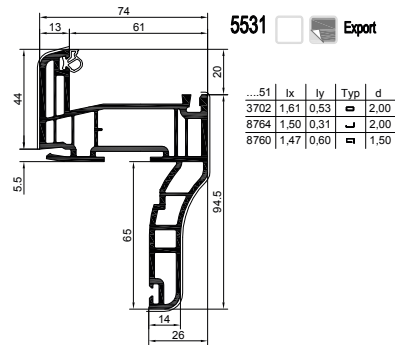
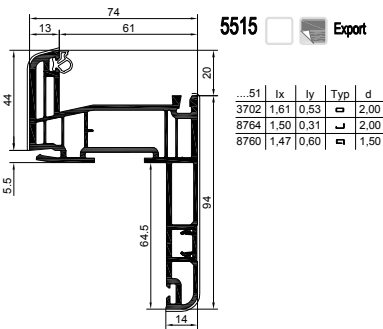
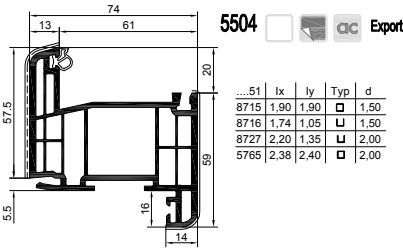
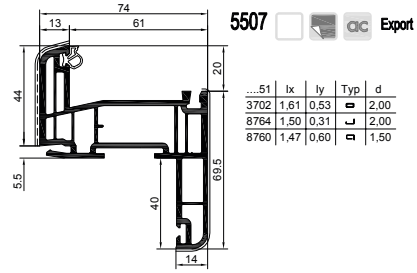
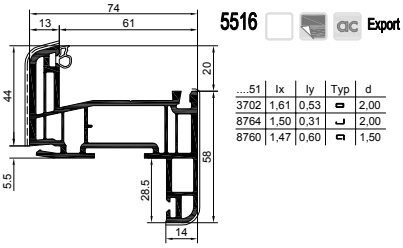

S 9000
S 9000 plus

GEALAN-KUBUS®

S 9000 NL

Stulp

Sprossen

Glasleisten

Aussteifungen

Dichtungen

Rahmenverbreiterungen

Kopplungsprofile

Eckprofile

Verleistungen

Untere Anschlussprofile

Laibungsverkleidungen

GEALAN
HAFEN-CITY-FENSTER®

Schwellen

Lüftungssystem

Hebeschiebesysteme

Schiebesysteme

Rollladen

Klappladen

Scuro

Cassonetto

Sonstiges

S 8000 IQ Pfosten · Mullions

3-Kammer

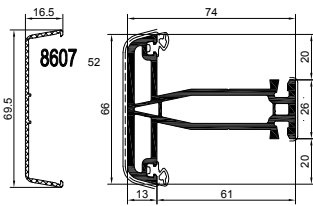

8036

...51	lx	ly	Typ	d
7706	2,40	0,82		2,00

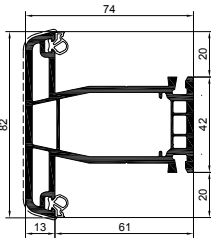
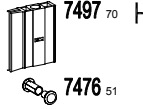

8037

...51	lx	ly	Typ	d
8701	5,92	2,87		2,00
8703	5,51	1,80		2,00
8751	4,50	2,25		1,50
8753	4,27	1,40		1,50

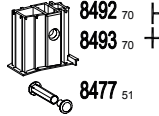

8477 51

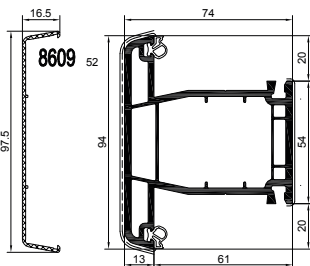
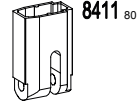
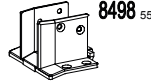

8040

...51	lx	ly	Typ	d
8713	10,20	5,78		2,00

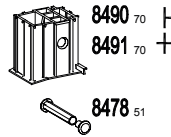

8478 51

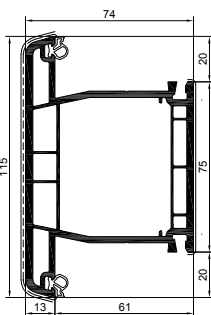
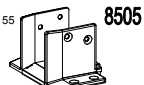
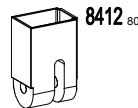

8043

...51	lx	ly	Typ	d
8708	11,46	19,12		2,00

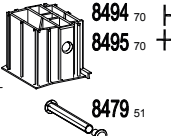

8479 51

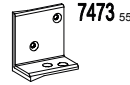

5-Kammer

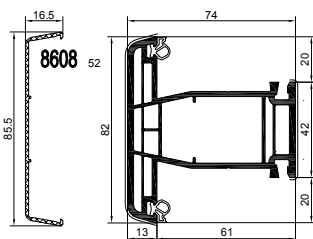

8038

...51	lx	ly	Typ	d
8715	1,62	1,63		1,50
8716	1,74	1,05		1,50
8727	2,20	1,35		2,00
5765	2,38	2,40		2,00



8477 51

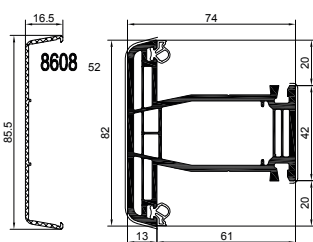
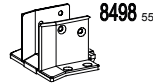

8039

...51	lx	ly	Typ	d
8701	5,92	2,87		2,00
8703	5,51	1,80		2,00
8751	4,50	2,25		1,50
8753	4,27	1,40		1,50

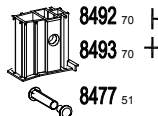

8477 51



8477 51

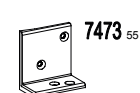

S 7000 IQ
S 7000 IQ plus

S 8000 IQ

S 9000
S 9000 plus

GEALAN-KUBUS®

S 9000 NL

Stulp

Sprossen

Glasleisten

Aussteifungen

Dichtungen

Rahmenverbreiterungen

Kopplungsprofile

Eckprofile

Verleistungen

Untere Anschlussprofile

Laibungsverkleidungen

GEALAN
HAFEN-CITY-FENSTER®

Schwellen

Lüftungssystem

Hebeschiebesysteme

Schiebesysteme

Rollladen

Klappladen

Scuro

Cassonetto

Sonstiges

S 8000 IQ Flügel · Sashes

S 7000 IQ
S 7000 IQ plus

4-Kammer

S 8000 IQ

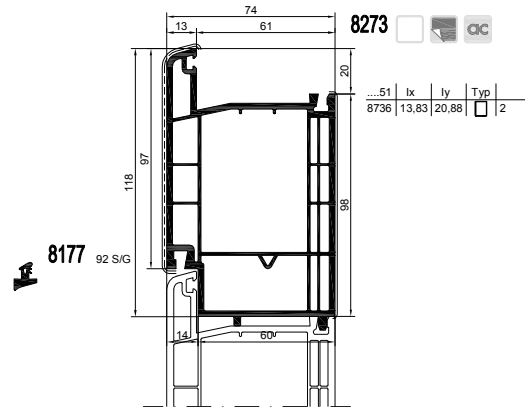
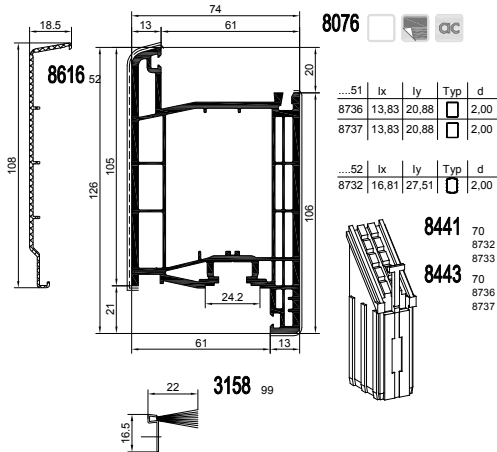
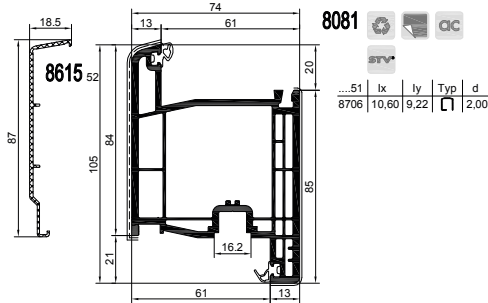
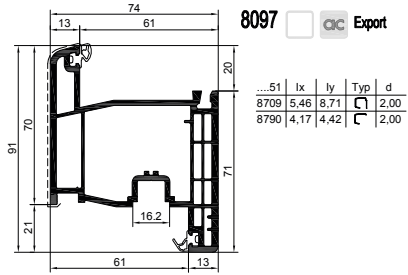
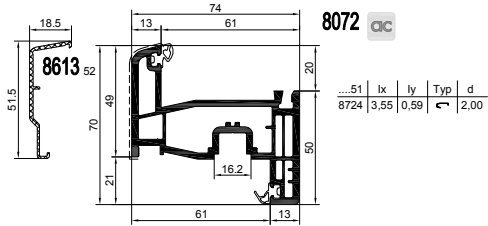

S 9000
S 9000 plus

GEALAN-KUBUS®

S 9000 NL

Stulp

Sprossen

Glasleisten

Aussteifungen

Dichtungen

Rahmenverbreiterungen

Kopplungsprofile

Eckprofile

Verleistungen

Untere Anschlussprofile

Laibungsverkleidungen

GEALAN
HAFEN-CITY-FENSTER®

Schwellen

5-Kammer

Hebeschiebesysteme

Schiebesysteme

Rollladen

Klappladen

Scuro

Cassonetto

Sonstiges

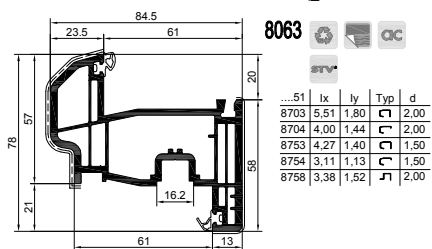
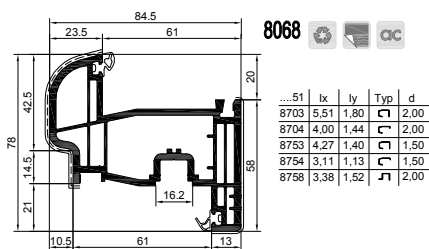
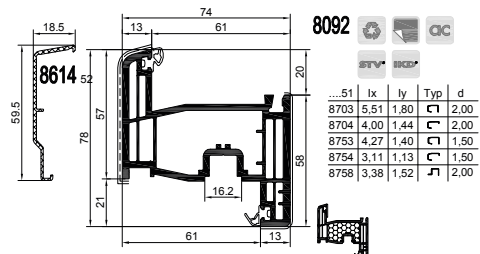
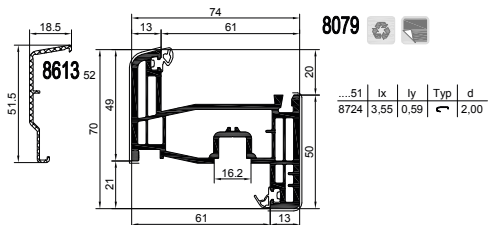

S 8000 IQ Flügel · Sashes

5-Kammer

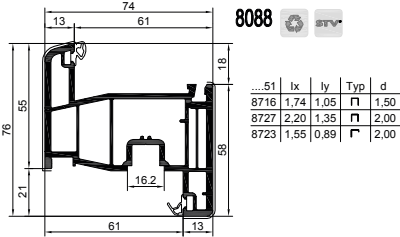

6-Kammer

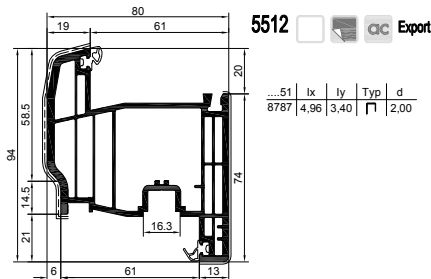
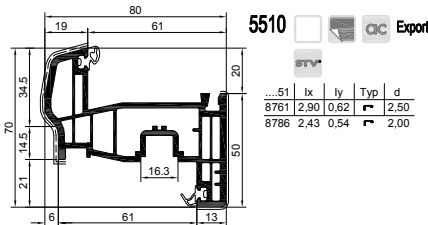
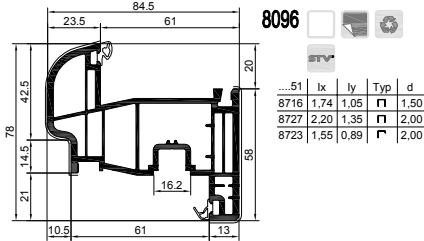
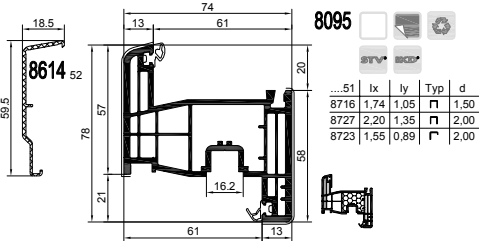

4-Kammer außenöffnend

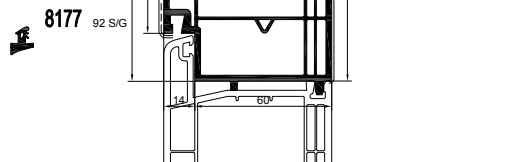
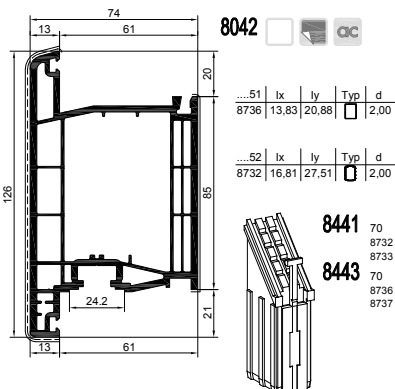
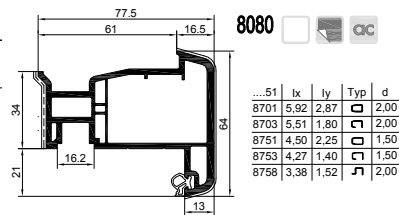
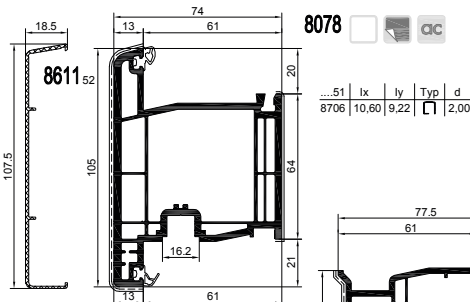
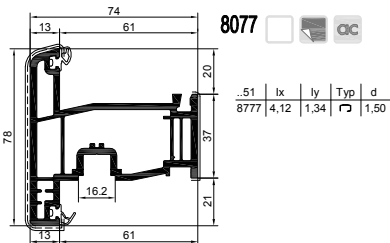

S 7000 IQ
S 7000 IQ plus

S 8000 IQ

S 9000
S 9000 plus

GEALAN-KUBUS*

S 9000 NL

Stulp

Sprossen

Glasleisten

Aussteifungen

Dichtungen

Rahmenverbreiterungen

Kopplungsprofile

Eckprofile

Verleistungen

Untere Anschlussprofile

Laibungsverkleidungen

GEALAN
HAFEN-CITY-FENSTER*

Schwellen

Lüftungssystem

Hebeschiebesysteme

Schiebesysteme

Rollladen

Klappladen

Scuro

Cassonetto

Sonstiges

S 9000 Blendrahmen · Frames

6-Kammer

S 7000 IQ
S 7000 IQ plus

S 8000 IQ

S 9000
S 9000 plus

GEALAN-KUBUS®

S 9000 NL

Stulp

Sprossen

Glasleisten

Aussteifungen

Dichtungen

Rahmenverbreiterungen

Kopplungsprofile

Eckprofile

Verleistungen

Untere Anschlussprofile

Laibungsverkleidungen

GEALAN
HAFEN-CITY-FENSTER®

Schwellen

Lüftungssystem

Hebeschiebesysteme

Schiebesysteme

Rollladen

Klappladen

Scuro

Cassonetto

Sonstiges

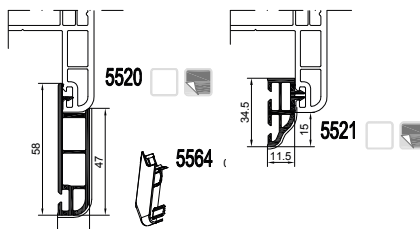
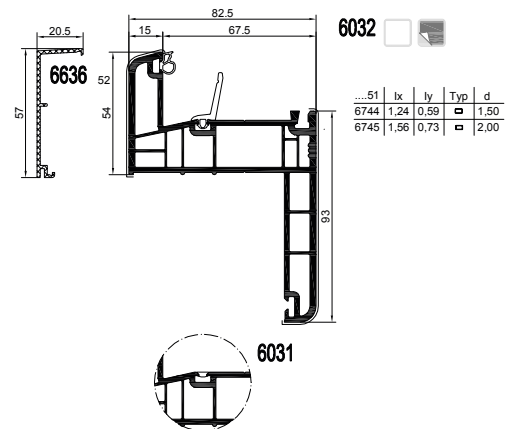
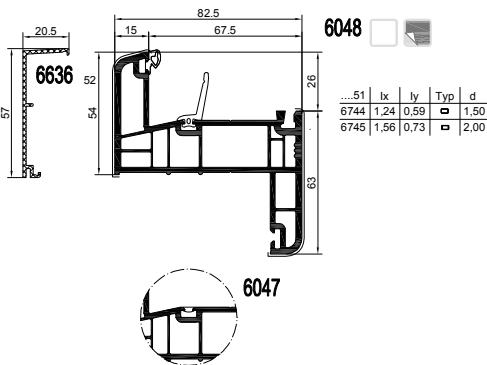
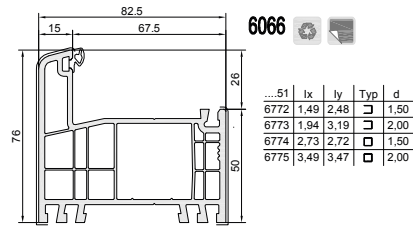
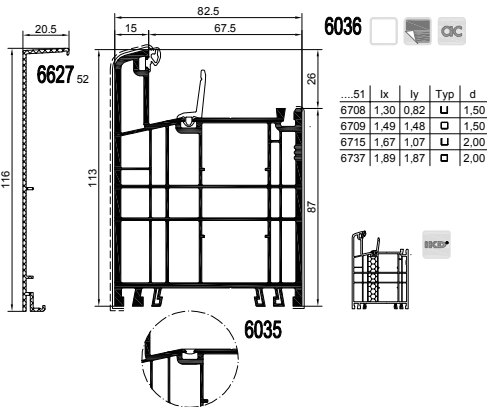
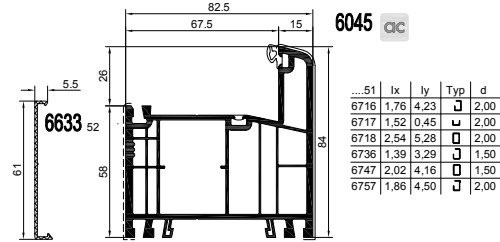
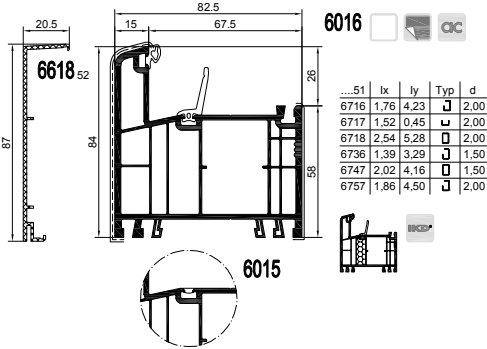
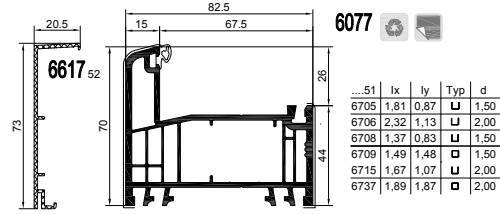
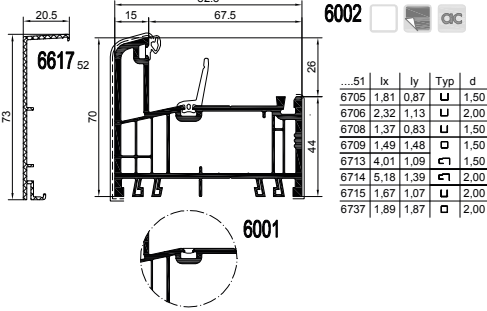

S 9000 plus Blendrahmen · Frames

6-Kammer

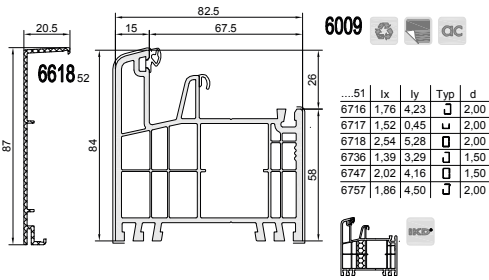

S 9000 Pfosten · Mullions

4-Kammer

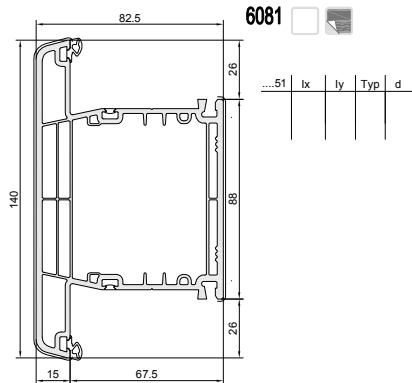
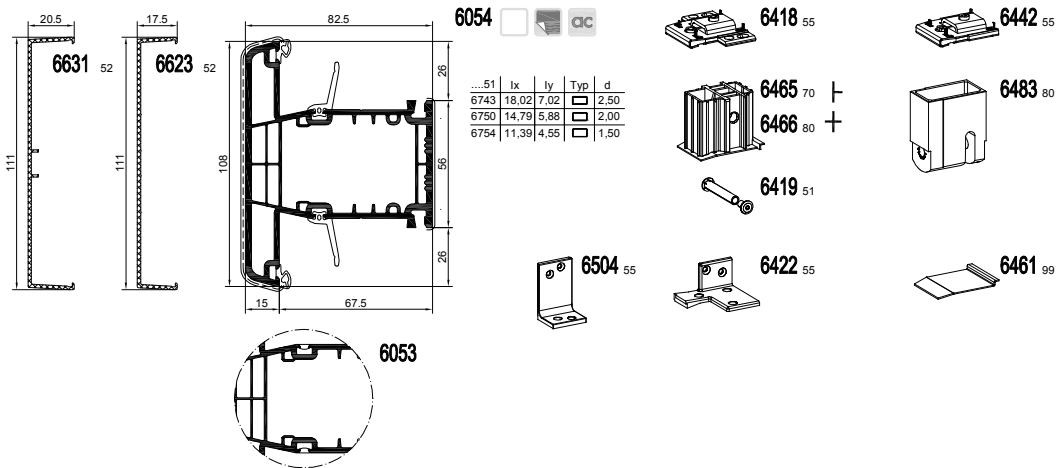

6-Kammer

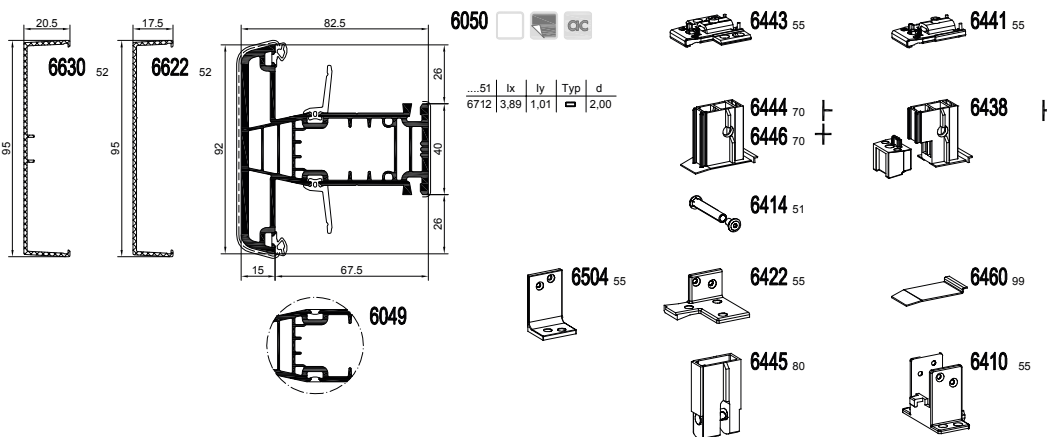

S 7000 IQ
S 7000 IQ plus

S 8000 IQ

S 9000
S 9000 plus

GEALAN-KUBUS®

S 9000 NL

Stulp

Sprossen

Glasleisten

Aussteifungen

Dichtungen

Rahmenverbreiterungen

Kopplungsprofile

Eckprofile

Verleistungen

Untere Anschlussprofile

Laibungsverkleidungen

GEALAN
HAFEN-CITY-FENSTER®

Schwellen

Lüftungssystem

Hebeschiebesysteme

Schiebesysteme

Rollladen

Klappladen

Scuro

Cassonetto

Sonstiges

S 9000 plus Pfosten · Mullions

- S 7000 IQ
S 7000 IQ plus
- S 8000 IQ
- S 9000
S 9000 plus**
- GEALAN-KUBUS®
- S 9000 NL
- Stulp
- Sprossen
- Glasleisten
- Aussteifungen
- Dichtungen
- Rahmenverbreiterungen
- Kopplungsprofile
- Eckprofile
- Verleistungen
- Untere Anschlussprofile
- Laibungsverkleidungen
- GEALAN
HAFEN-CITY-FENSTER®
- Schwellen
- Lüftungssystem
- Hebeschiebesysteme
- Schiebesysteme
- Rollladen
- Klappläden
- Scuro
- Cassonetto
- Sonstiges

4-Kammer

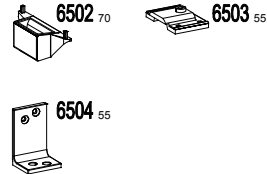
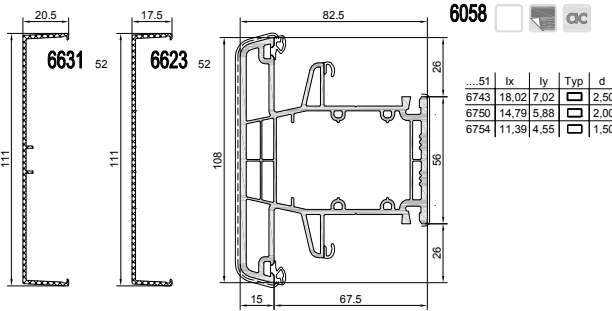
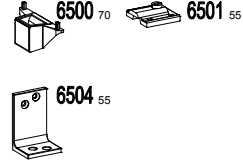
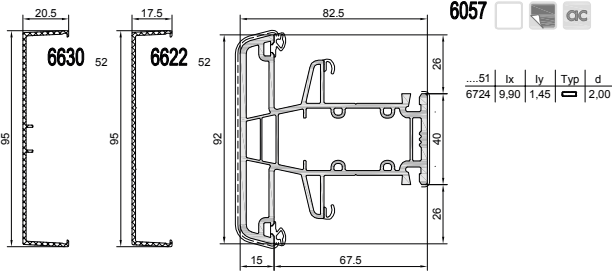

S 9000 Flügel · Sashes

6-Kammer

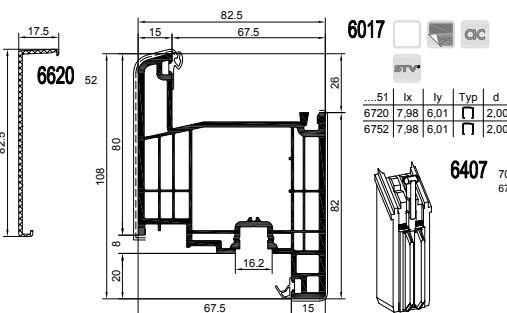
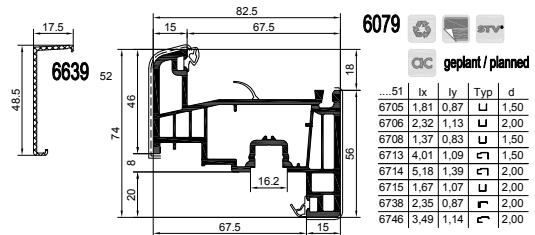
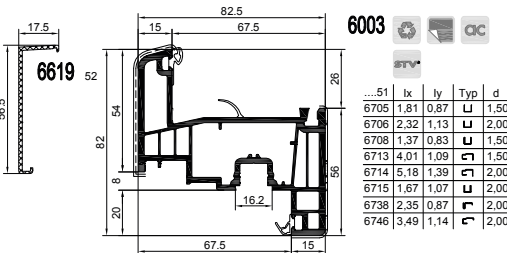
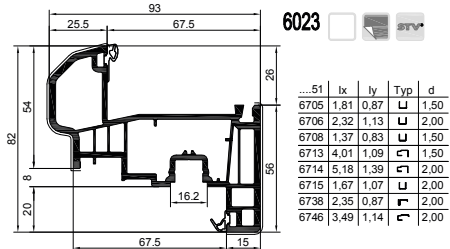
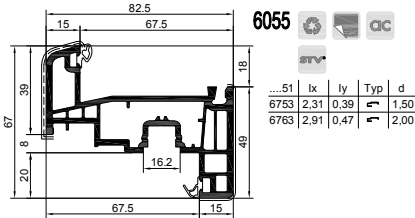

S 9000 Flügel · Sashes

6-Kammer

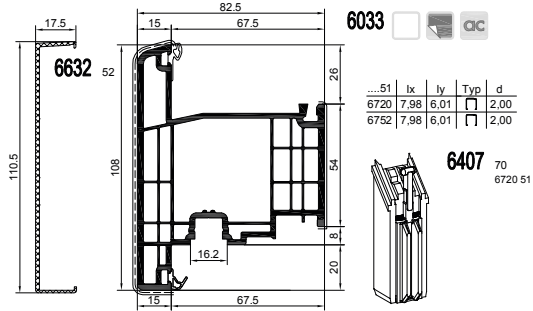
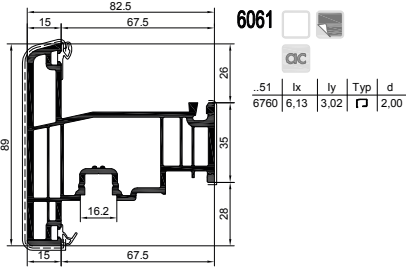

S 7000 IQ
S 7000 IQ plus

S 8000 IQ

S 9000
S 9000 plus

GEALAN-KUBUS®

S 9000 NL

Stulp

Sprossen

Glasleisten

Aussteifungen

Dichtungen

Rahmenverbreiterungen

Kopplungsprofile

Eckprofile

Verleistungen

Untere Anschlussprofile

Laibungsverkleidungen

GEALAN
HAFEN-CITY-FENSTER®

Schwellen

Lüftungssystem

Hebeschiebesysteme

Schiebesysteme

Rollladen

Klappladen

Scuro

Cassonetto

Sonstiges

5-Kammer Haustür

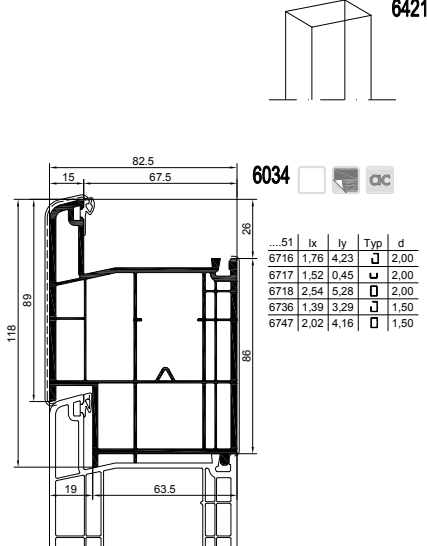
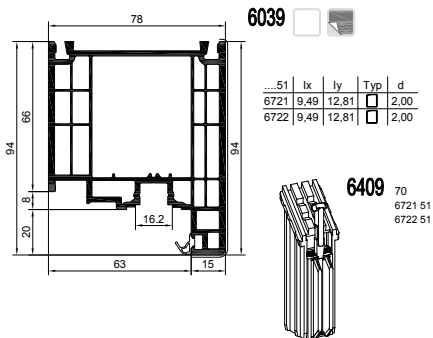
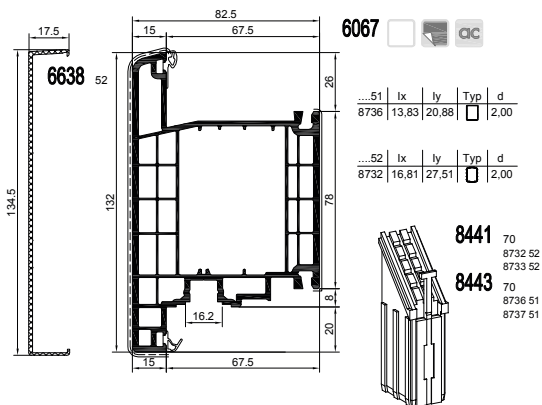
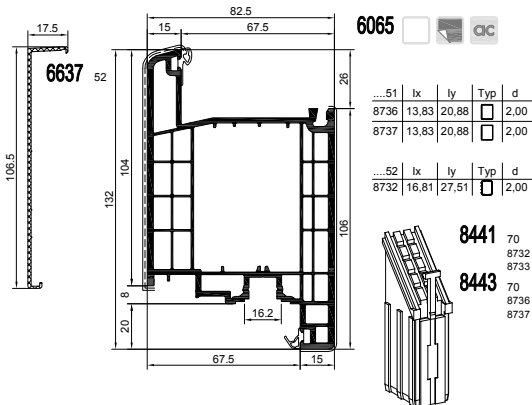
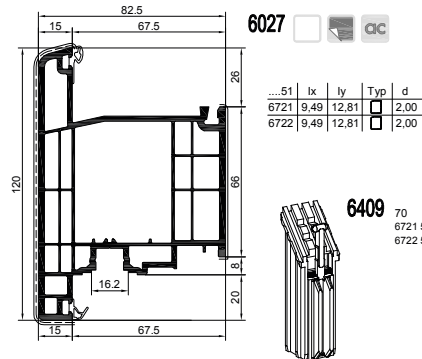
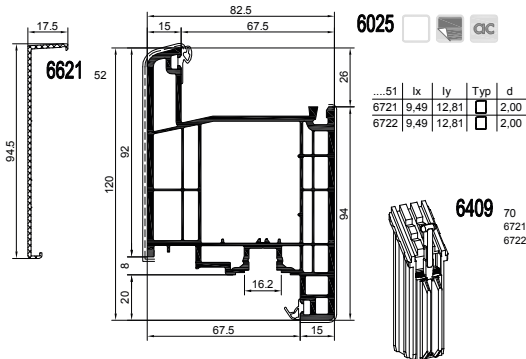

S 7000 IQ
S 7000 IQ plus

Blendrahmen · Frames

S 8000 IQ

S 9000
S 9000 plus

GEALAN-KUBUS®

S 9000 NL

Stulp

Sprossen

Glasleisten

Aussteifungen

Dichtungen

Rahmenverbreiterungen

Kopplungsprofile

Eckprofile

Verleistungen

Untere Anschlussprofile

Laibungsverkleidungen

GEALAN
HAFEN-CITY-FENSTER®

Schwellen

Lüftungssystem

Hebeschiebesysteme

Schiebesysteme

Rollladen

Klappladen

Scuro

Sonstiges · Miscellaneous

Cassonetto

Sonstiges

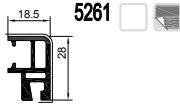
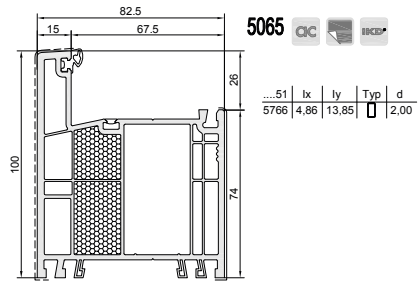
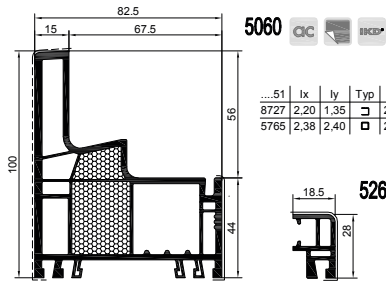

Pfosten · Mullions

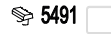
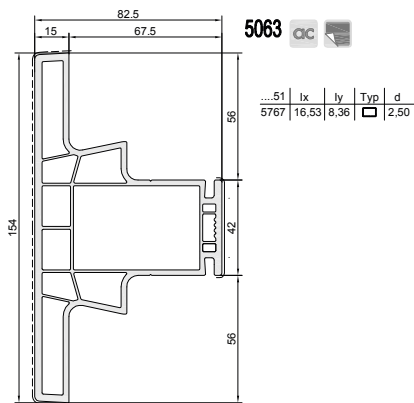
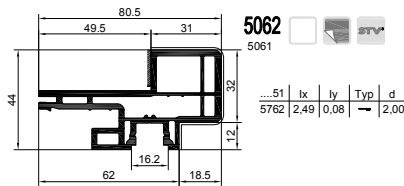
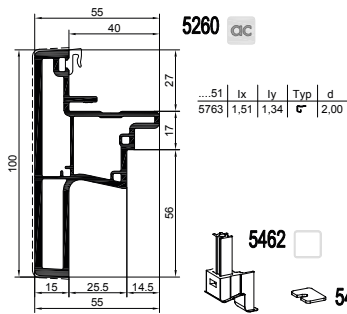

Flügel · Sashes

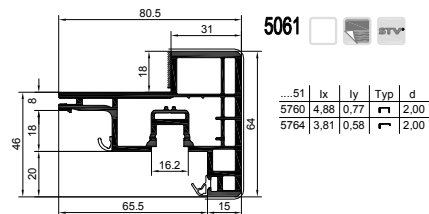

S 9000 NL

S 9000 NL 120 mm

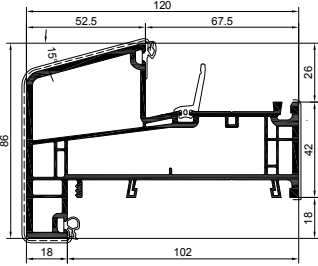

6802

...51	lx	ly	Typ	d
6755	29,66	2,4		2,00
6768	22,74	1,91		1,50
2724	4,22	1,39		2,00

...52	lx	ly	Typ	d
6766	7,42	2,76		2,50

...EO Typ
6212

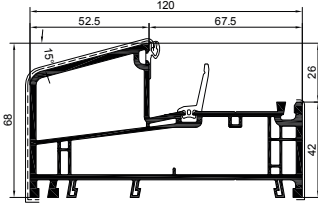

6806

...51	lx	ly	Typ	d
6755	29,66	2,4		2,00
6768	22,74	1,91		1,50
2724	4,22	1,39		2,00

...52	lx	ly	Typ	d
6766	7,42	2,76		2,50

...EO Typ
6212

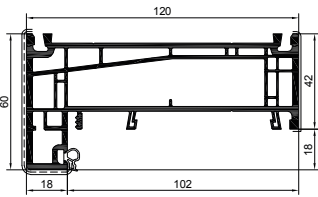

6821

...51	lx	ly	Typ	d
6755	29,66	2,4		2,00
6768	22,74	1,91		1,50
2724	4,22	1,39		2,00

...EO Typ
6212

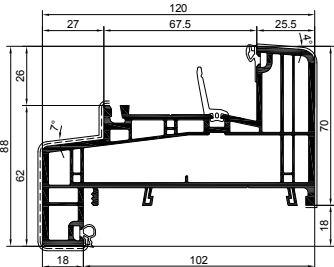

6808

...51	lx	ly	Typ	d
6755	29,66	2,4		2,00
6768	22,74	1,91		1,50
2724	4,22	1,39		2,00

...EO Typ
6212

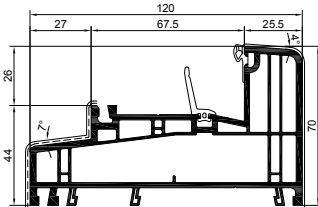

6820

...51	lx	ly	Typ	d
6755	29,66	2,4		2,00
6768	22,74	1,91		1,50
2724	4,22	1,39		2,00

...EO Typ
6212

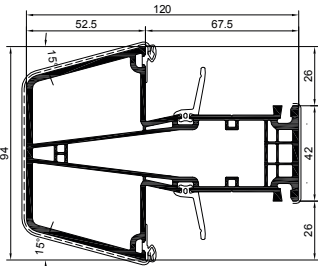
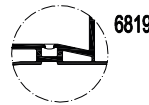

6816

...51	lx	ly	Typ	d
2724	4,22	1,39		2,00
6769	20,92	1,58		1,50
6758	27,26	1,97		2,00

...52	lx	ly	Typ	d
6766	7,42	2,76		2,50

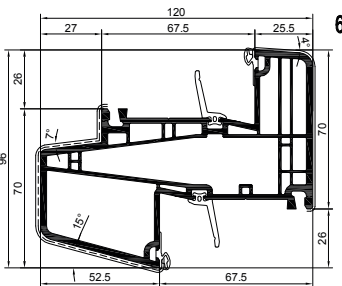
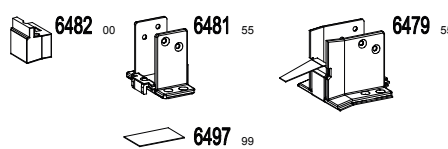
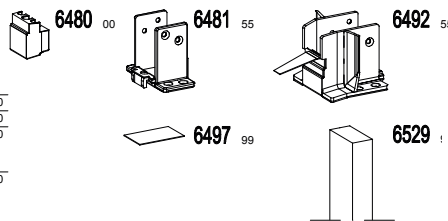

6810

...51	lx	ly	Typ	d
2724	4,22	1,39		2,00
6769	20,92	1,58		1,50
6758	27,26	1,97		2,00
6767	26,25	1,93		2,00

...52	lx	ly	Typ	d
6766	7,42	2,76		2,50

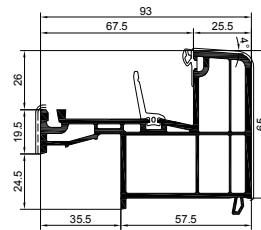

6842

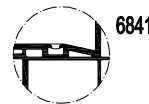

S 7000 IQ
S 7000 IQ plus

S 8000 IQ

S 9000
S 9000 plus

GEALAN-KUBUS®

S 9000 NL

Stulp

Sprossen

Glasleisten

Aussteifungen

Dichtungen

Rahmenverbreiterungen

Kopplungsprofile

Eckprofile

Verleistungen

Untere Anschlussprofile

Laibungsverkleidungen

GEALAN
HAFEN-CITY-FENSTER®

Schwellen

Lüftungssystem

Hebeschiebesysteme

Schiebesysteme

Rollladen

Klappladen

Scuro

Cassonetto

Sonstiges

S 9000 NL

S 9000 NL 120 mm

S 7000 IQ
S 7000 IQ plus

S 8000 IQ

S 9000
S 9000 plus

GEALAN-KUBUS®

S 9000 NL

Stulp

Sprossen

Glasleisten

Aussteifungen

Dichtungen

Rahmenverbreiterungen

Kopplungsprofile

Eckprofile

Verleistungen

Untere Anschlussprofile

Laibungsverkleidungen

GEALAN
HAFEN-CITY-FENSTER®

Schwellen

Lüftungssystem

Hebeschiebesysteme

Schiebesysteme

Rollladen

Klappladen

Scuro

Cassonetto

Sonstiges

6804

...51	lx	ly	Typ	d
6755	29,66	2,40		2,00
6768	22,74	1,91		1,50
2724	4,22	1,39		2,00

...52	lx	ly	Typ	d
6771	9,58	6,19		2,50

...EO Typ
6212



6814

...51	lx	ly	Typ	d
6755	29,66	2,40		2,00
6768	22,74	1,91		1,50
2724	4,22	1,39		2,00

...52	lx	ly	Typ	d
6771	9,58	6,19		2,50

...EO Typ
6212



6808

...51	lx	ly	Typ	d
6755	29,66	2,4		2,00
6768	22,74	1,91		1,50
2724	4,22	1,39		2,00

...EO Typ
6212



6820

...51	lx	ly	Typ	d
6755	29,66	2,4		2,00
6768	22,74	1,91		1,50
2724	4,22	1,39		2,00

...EO Typ
6212



6818

...51	lx	ly	Typ	d
2724	4,22	1,39		2,00
6769	20,92	1,58		1,50
6758	27,26	1,97		2,00

...52	lx	ly	Typ	d
6771	9,58	6,19		2,50



6480 00

6481 55

6492 55

6497 99

6529 1

6482 00

6481 55

6479 55

6497 99

6812

...51	lx	ly	Typ	d
2724	4,22	1,39		2,00
6769	20,92	1,58		1,50
6758	27,26	1,97		2,00

...52	lx	ly	Typ	d
6771	9,58	6,19		2,50



6844

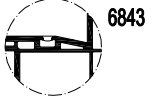

S 9000 NL

S 9000 NL 120 mm

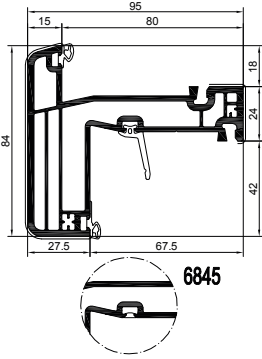

6846

...51	lx	ly	Typ	d
6764	11.04	7.63		1,50

6115 80 s



6845

S 9000 NL 82,5 mm

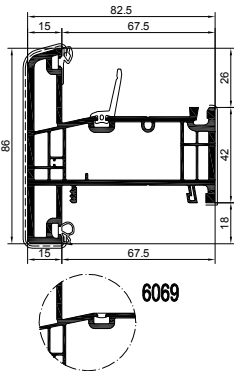

6070

...51	lx	ly	Typ	d
2724	4,22	1,39		2,00
6770	7,31	1,63		2,00

6069

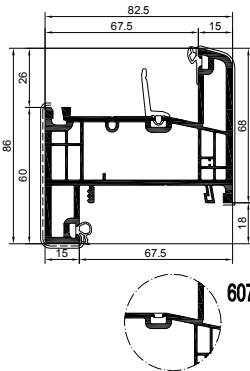

6072

...51	lx	ly	Typ	d
2724	4,22	1,39		2,00
6770	7,31	1,63		2,00

6071

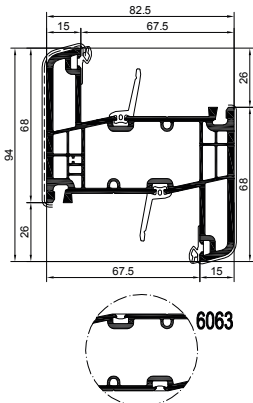

6064

...51	lx	ly	Typ	d
2724	4,22	1,39		2,00
6770	7,31	1,63		2,00

6063

3151 80 s



6212

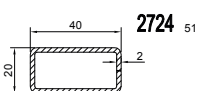
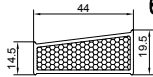

2724 51

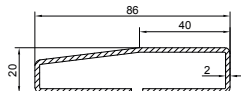

6755 51

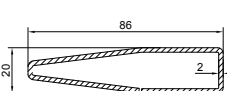

6758 51

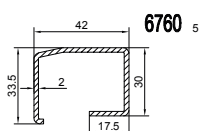

6760 51

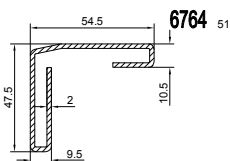

6764 51

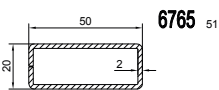

6765 51

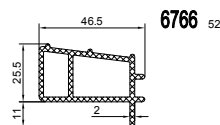

6766 52

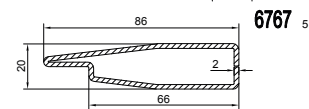

6767 51

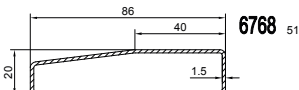

6768 51

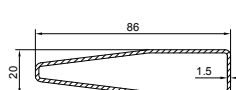

6769 51

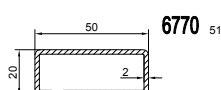

6770 51

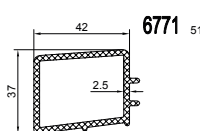

6771 51

S 7000 IQ
S 7000 IQ plus

S 8000 IQ

S 9000
S 9000 plus

GEALAN-KUBUS*

S 9000 NL

Stulp

Sprossen

Glasleisten

Aussteifungen

Dichtungen

Rahmenverbreiterungen

Kopplungsprofile

Eckprofile

Verleistungen

Untere Anschlussprofile

Laibungsverkleidungen

GEALAN
HAFEN-CITY-FENSTER®

Schwellen

Lüftungssystem

Hebeschiebesysteme

Schiebesysteme

Rollladen

Klappladen

Scuro

Cassonetto

Sonstiges

Stulp · French Casement

S 7000 IQ plus

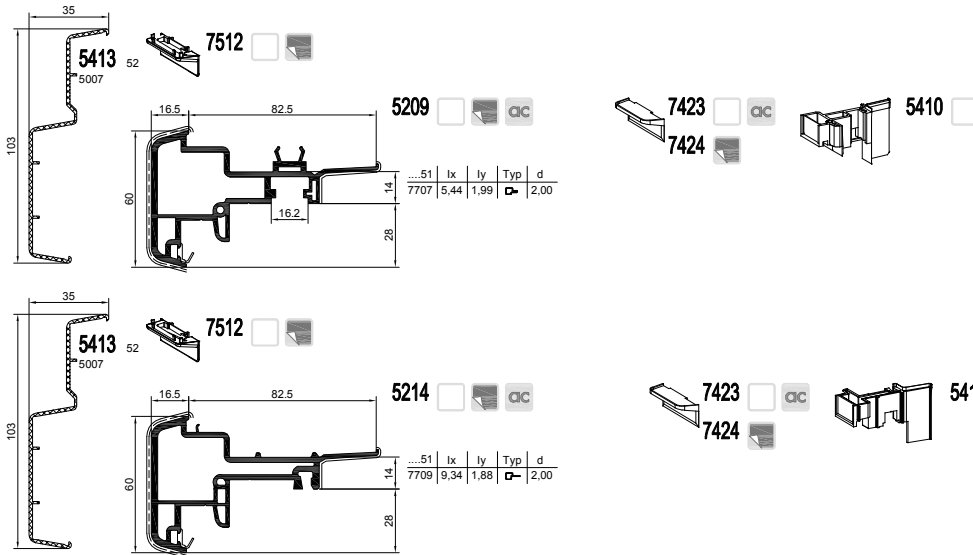

S 7000 IQ plus Monostulp

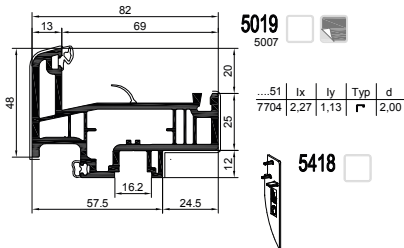

S 8000 IQ

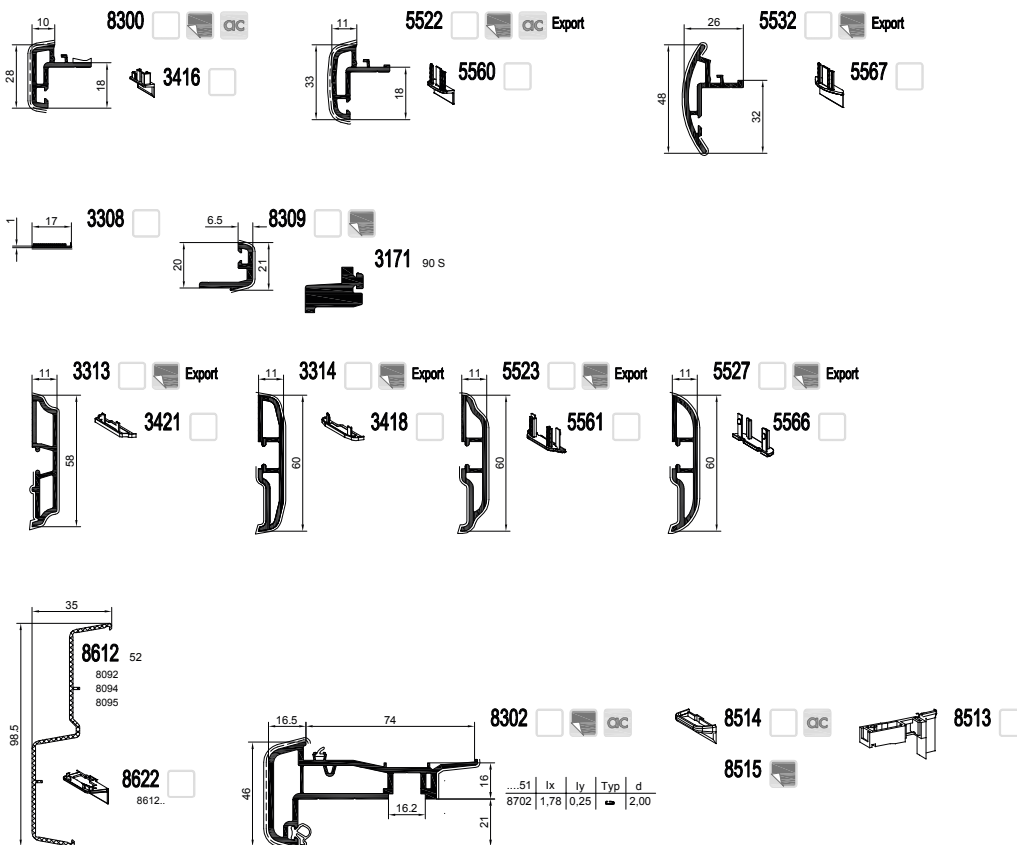

S 7000 IQ
S 7000 IQ plus

S 8000 IQ

S 9000
S 9000 plus

GEALAN-KUBUS*

S 9000 NL

Stulp

Sprossen

Glasleisten

Aussteifungen

Dichtungen

Rahmenverbreiterungen

Kopplungsprofile

Eckprofile

Verleistungen

Untere Anschlussprofile

Laibungsverkleidungen

GEALAN
HAFEN-CITY-FENSTER®

Schwellen

Lüftungssystem

Hebeschiebesysteme

Schiebesysteme

Rollladen

Klappläden

Scuro

Cassonetto

Sonstiges

Stulp · French Casement

S 7000 IQ
S 7000 IQ plus

S 8000 IQ

S 8000 IQ

S 9000
S 9000 plus

GEALAN-KUBUS®

S 9000 NL

Stulp

Sprossen

Glasleisten

Aussteifungen

Dichtungen

Rahmenverbreiterungen

Kopplungsprofile

Eckprofile

Verleistungen

Untere Anschlussprofile

Laibungsverkleidungen

GEALAN
HAFEN-CITY-FENSTER®

Schwellen

Lüftungssystem

Hebeschiebesysteme

Schiebesysteme

Rollladen

Klappladen

Scuro

Cassonetto

Sonstiges

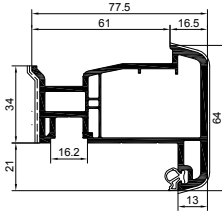

8080

...51	lx	ly	Typ	d
8701	5.92	2.87	□	2,00
8703	5.51	1.80	□	2,00
8751	4.50	2.25	□	1,50
8753	4.27	1.40	□	1,50
8758	3.38	1.52	□	2,00



8401 70



8516



8511



8510

8512

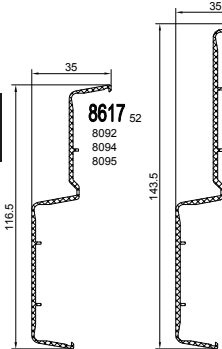

8618 52

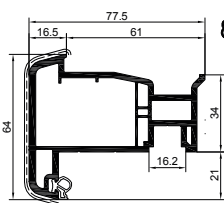

8304

...51	lx	ly	Typ	d
8701	5.92	2.87	□	2,00
8703	5.51	1.80	□	2,00
8751	4.50	2.25	□	1,50
8753	4.27	1.40	□	1,50
8758	3.38	1.52	□	2,00



8401 70



8510



8511



8516



8621

S 8000 IQ Monostulp

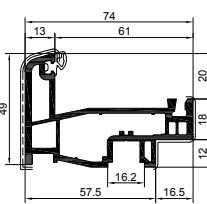

8073

...51	lx	ly	Typ	d
8724	3.55	0.59	□	2,00

8415

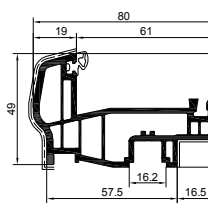

5511

...51	lx	ly	Typ	d
8761	2.90	0.62	□	2,50

8415

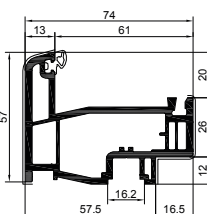

8069

...51	lx	ly	Typ	d
8704	4.00	1.44	□	2,00
8754	3.11	1.13	□	1,50

8415

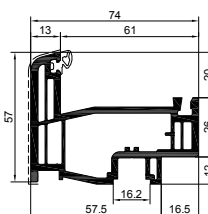

8071

...51	lx	ly	Typ	d
8704	4.00	1.44	□	2,00
8754	3.11	1.13	□	1,50

8415

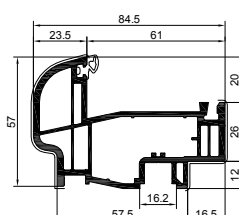

8074

...51	lx	ly	Typ	d
8704	4.00	1.44	□	2,00
8754	3.11	1.13	□	1,50

8415

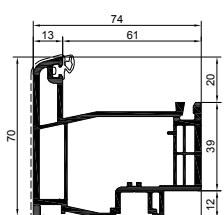

8098

...51	lx	ly	Typ	d
8790	4.17	4.42	□	2,00

8415

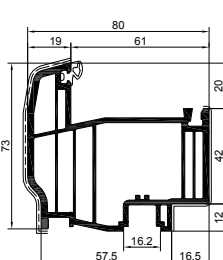

5513

...51	lx	ly	Typ	d
8787	4.96	3.50	□	2,00

8415

Stulp · French Casement

S 9000

S 7000 IQ
S 7000 IQ plus

S 8000 IQ

S 9000
S 9000 plus

GEALAN-KUBUS*

S 9000 NL

Stulp

Sprossen

Glasleisten

Aussteifungen

Dichtungen

Rahmenverbreiterungen

Kopplungsprofile

Eckprofile

Verleistungen

Untere Anschlussprofile

Laibungsverkleidungen

GEALAN
HAFEN-CITY-FENSTER®

Schwellen

Lüftungssystem

Hebeschiebesysteme

Schiebesysteme

Rollladen

Klappläden

Scuro

Cassonetto

Sonstiges

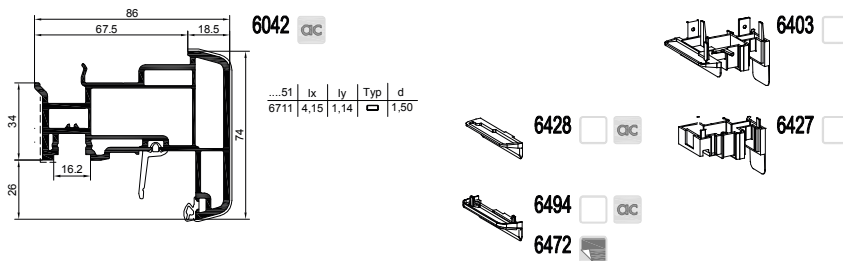
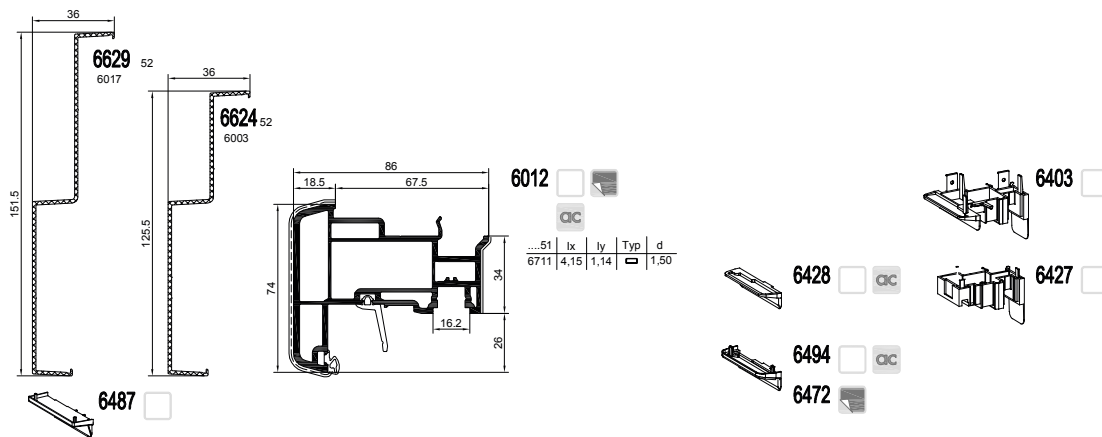
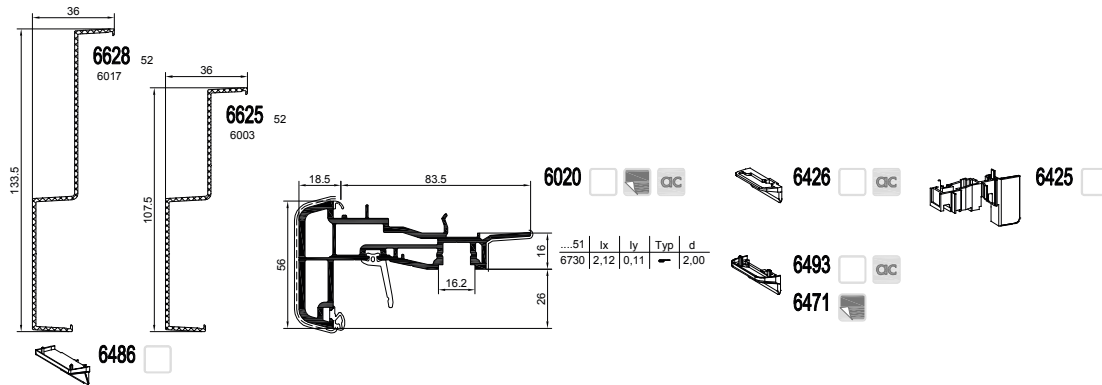
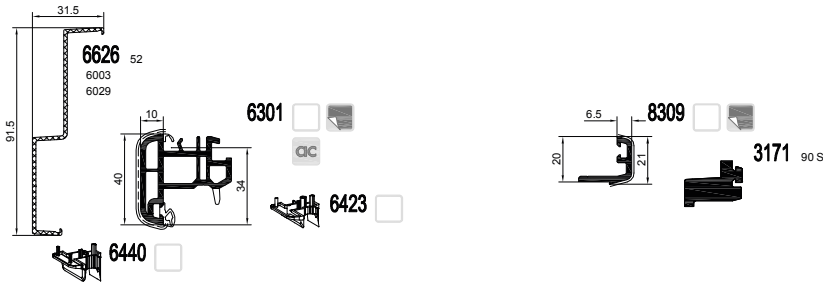

Stulp · French Casement

S 7000 IQ
S 7000 IQ plus

S 9000 Monostulp

S 8000 IQ

S 9000
S 9000 plus

GEALAN-KUBUS®

S 9000 NL

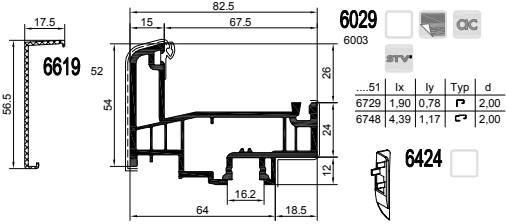
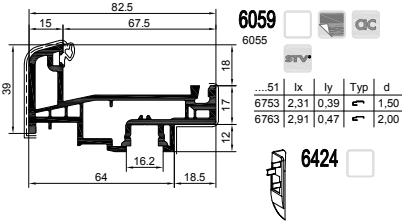

Stulp

GEALAN-KUBUS® Monostulp

Sprossen

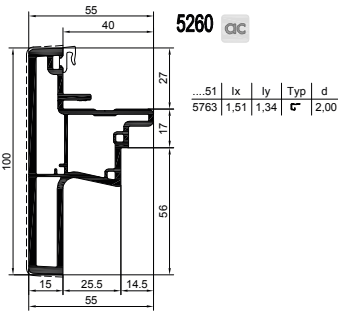

Glasleisten

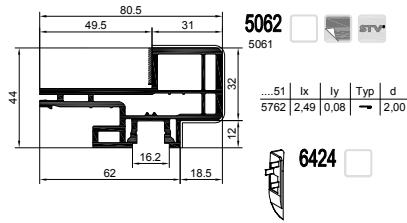

Aussteifungen

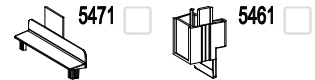

Dichtungen

Rahmenverbreiterungen

Kopplungsprofile

Eckprofile

Verleistungen

Untere Anschlussprofile

Laibungsverkleidungen

GEALAN
HAFEN-CITY-FENSTER®

Schwellen

Lüftungssystem

Hebeschiebesysteme

Schiebesysteme

Rollladen

Klappläden

Scuro

Cassonetto

Sonstiges

Sprossen · Muntins

System unabhängig

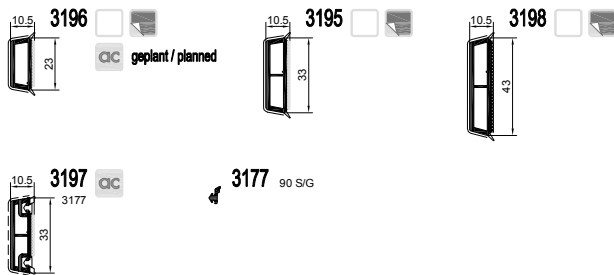

S 7000 IQ
S 7000 IQ plus

S 8000 IQ

S 9000
S 9000 plus

GEALAN-KUBUS*

S 9000 NL

Stulp

S 7000 IQ

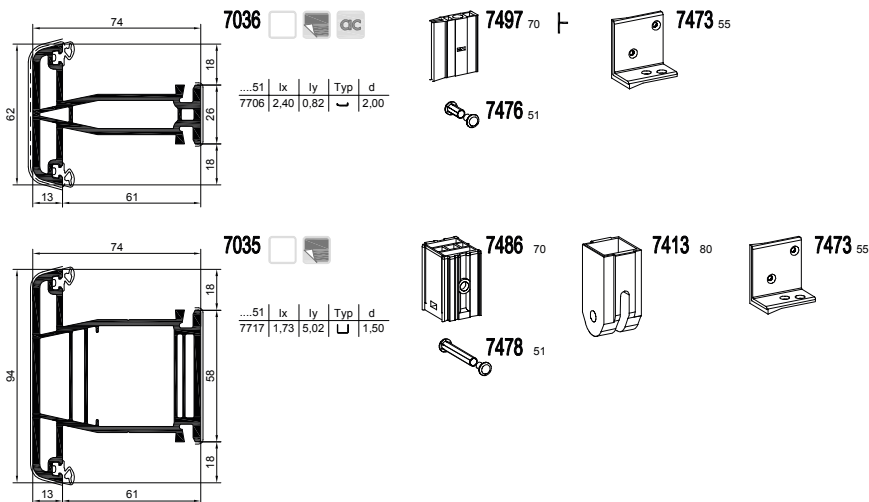

S 8000 IQ

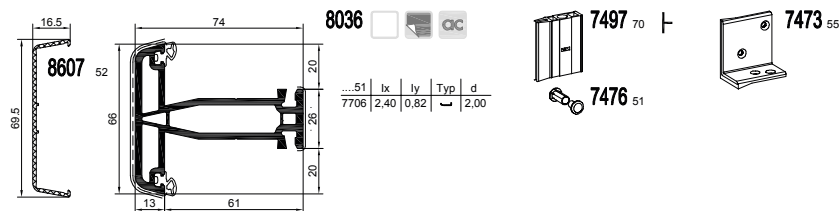

S 7000 IQ plus

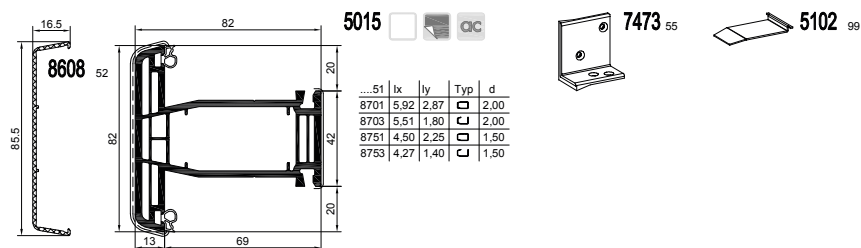

Sprossen

Glasleisten

Aussteifungen

Dichtungen

Rahmenverbreiterungen

Kopplungsprofile

Eckprofile

Verleistungen

Untere Anschlussprofile

Laibungsverkleidungen

GEALAN
HAFEN-CITY-FENSTER®

Schwellen

Lüftungssystem

Hebeschiebesysteme

Schiebesysteme

Rollladen

Klappläden

Scuro

Cassonetto

Sonstiges

Glasleisten · Glazing Beads

S 7000 IQ
S 7000 IQ plus

S 7000 IQ / 7000 IQ plus

S 8000 IQ



S 9000
S 9000 plus

GEALAN-KUBUS®

S 7000 IQ / S 8000 IQ / S 7000 IQ plus / HST S 8000 IQ / Schiebeseysteme

S 9000 NL

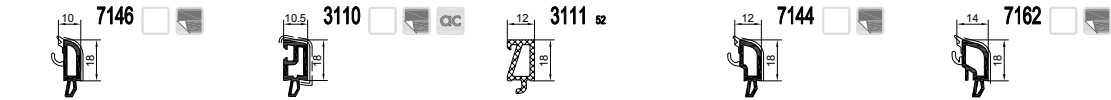

Stulp

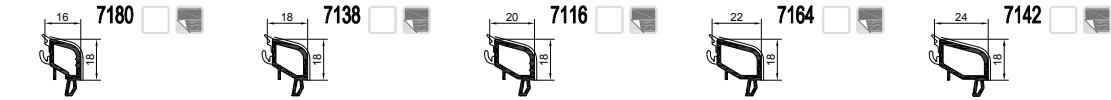

Sprossen

Glasleisten

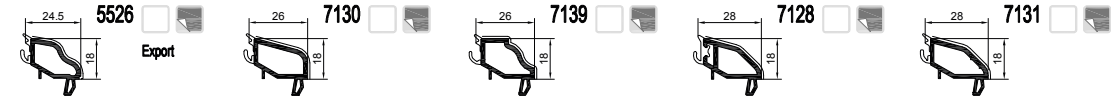

Aussteifungen

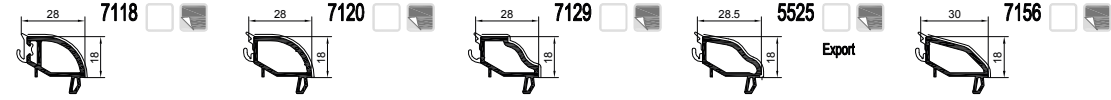

Dichtungen

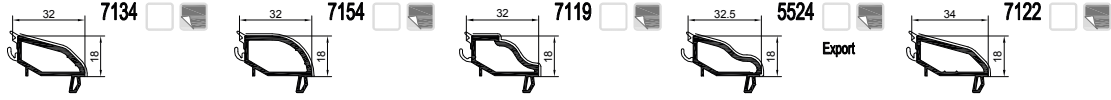

Rahmenverbreiterungen

Kopplungsprofile



Eckprofile

Verleistungen



Untere Anschlussprofile

S 9000 / HST S 9000 / S 9000 NL / S 9000 plus

Laibungsverkleidungen

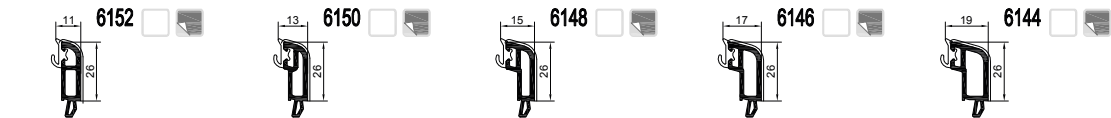

GEALAN
HAFEN-CITY-FENSTER®

Schwellen

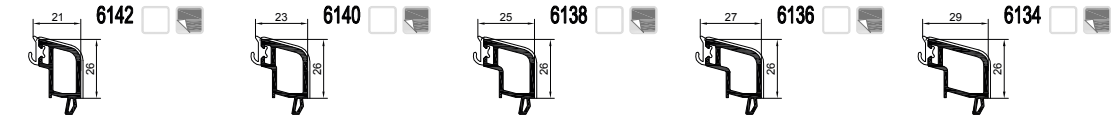

Lüftungssystem

Hebeschiebesysteme

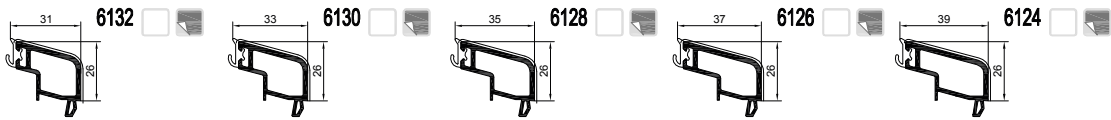

Schiebesysteme

Rollladen

Klappläden

Scuro

Cassonetto

Sonstiges

Aussteifungen · Reinforcements

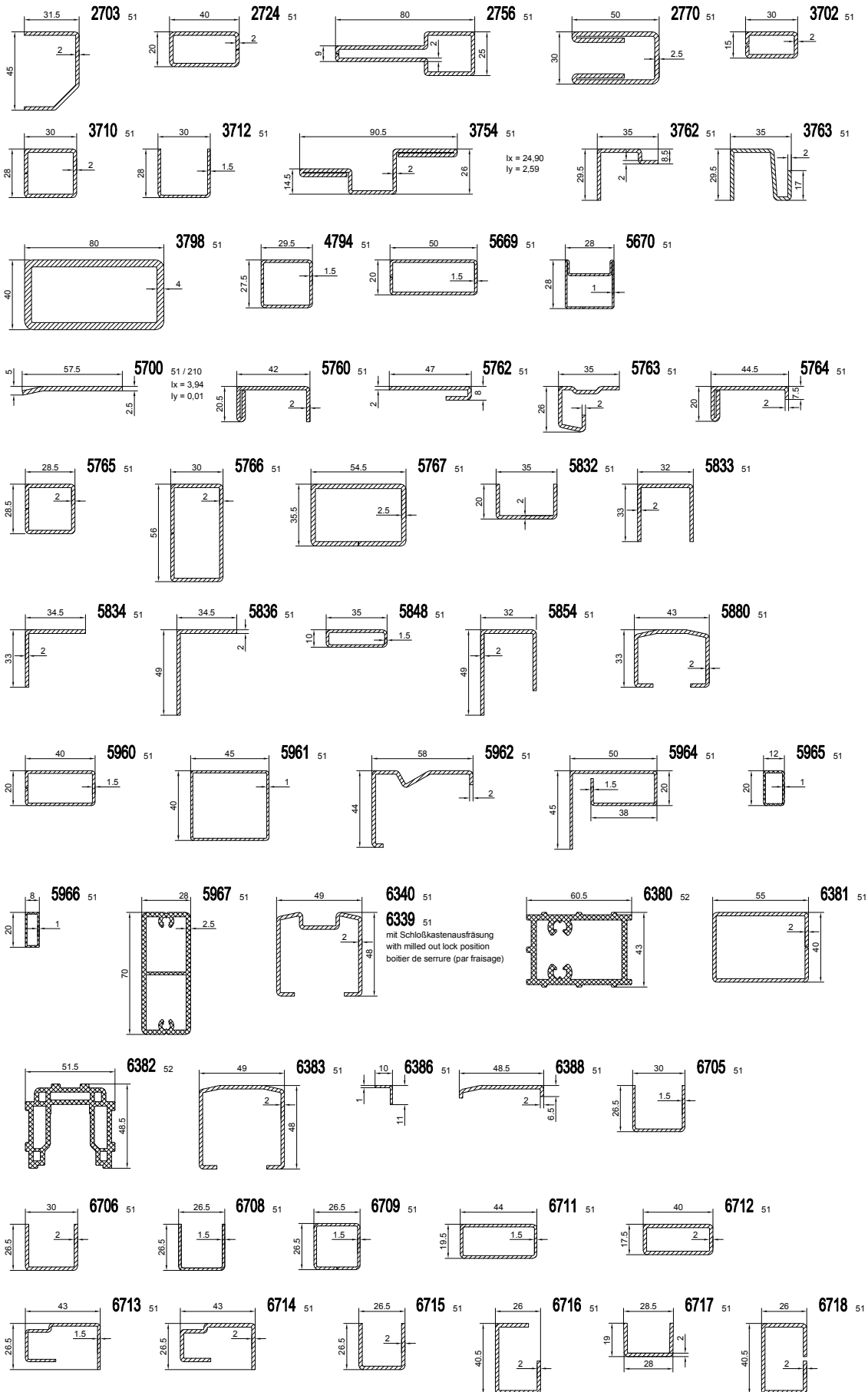

S 7000 IQ
S 7000 IQ plus

S 8000 IQ

S 9000
S 9000 plus

GEALAN-KUBUS®

S 9000 NL

Stulp

Sprossen

Glasleisten

Aussteifungen

Dichtungen

Rahmenverbreiterungen

Kopplungsprofile

Eckprofile

Verleistungen

Untere Anschlussprofile

Laibungsverkleidungen

GEALAN
HAFEN-CITY-FENSTER®

Schwellen

Lüftungssystem

Hebeschiesesysteme

Schiebesysteme

Rollladen

Klappladen

Scuro

Cassonetto

Sonstiges

Aussteifungen · Reinforcements

S 7000 IQ
S 7000 IQ plus

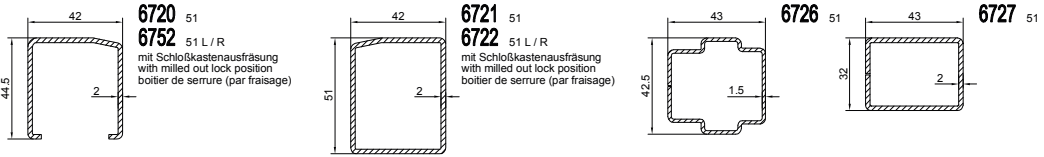

S 8000 IQ

S 9000
S 9000 plus

GEALAN-KUBUS®

S 9000 NL

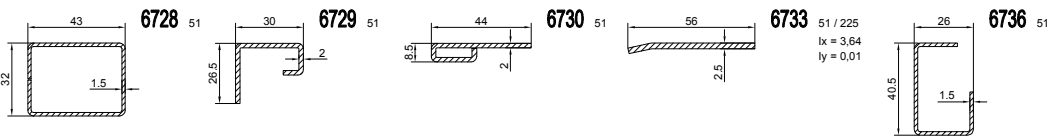

Stulp

Sprossen

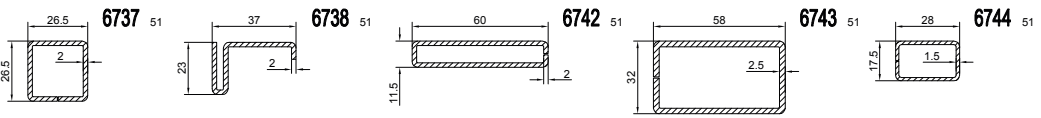

Glasleisten

Aussteifungen

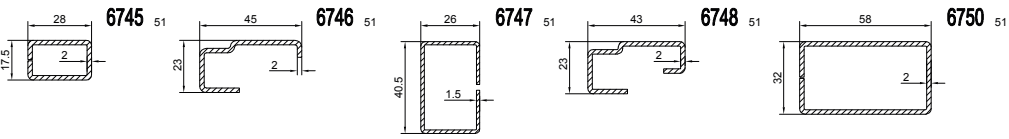

Dichtungen

Rahmenverbreiterungen

Kopplungsprofile

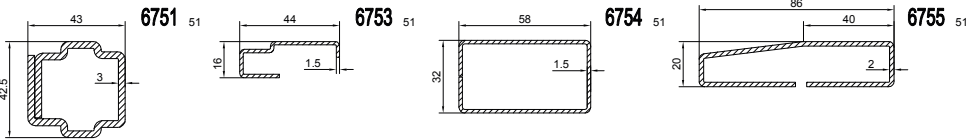

Eckprofile

Verleistungen

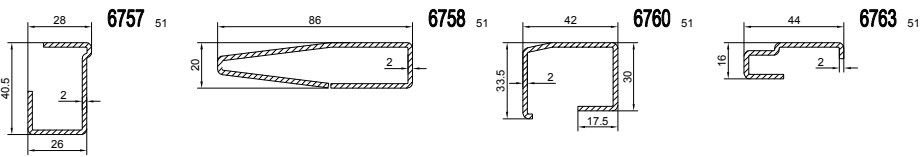

Untere Anschlussprofile

Laibungsverkleidungen

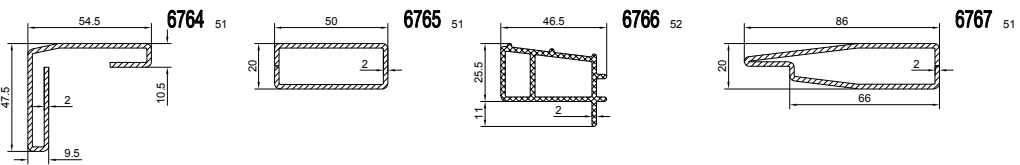

GEALAN
HAFEN-CITY-FENSTER®

Schwellen

Lüftungssystem

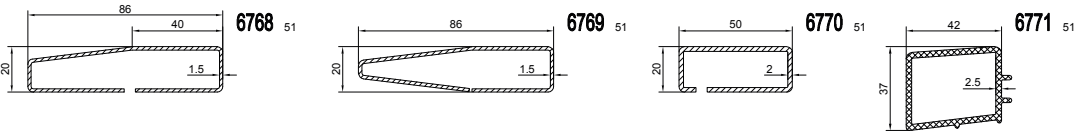

Hebeschiebesysteme

Schiebesysteme

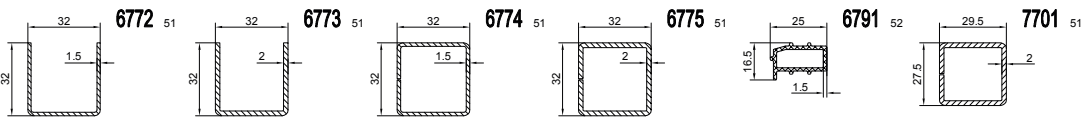

Rollladen

Klappladen

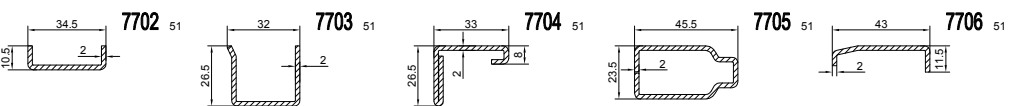

Scuro

Cassonetto

Sonstiges

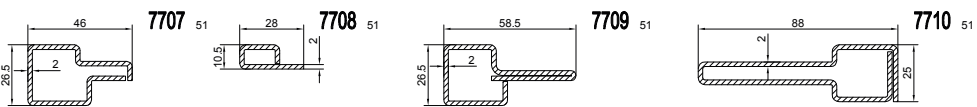

Aussteifungen · Reinforcements

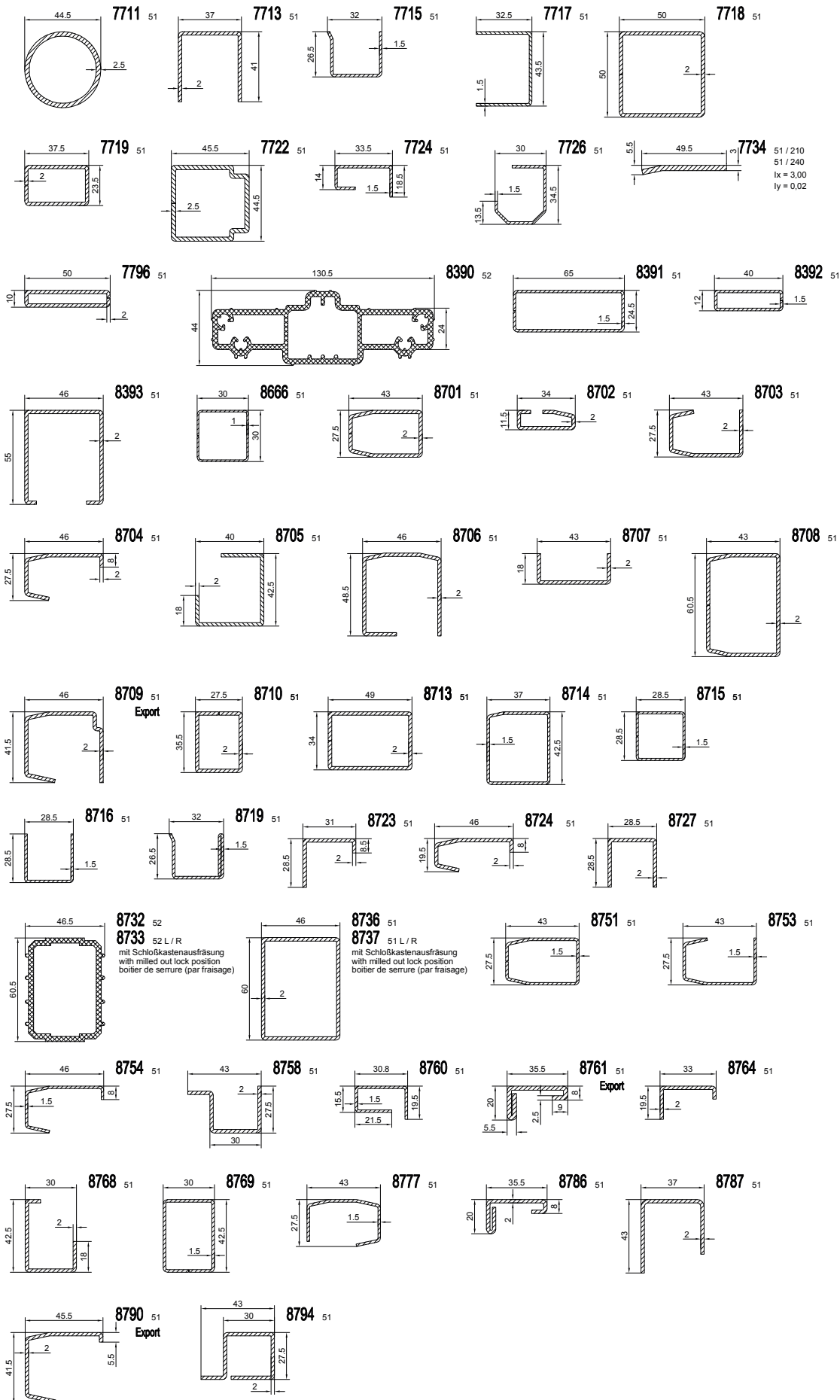

S 7000 IQ
S 7000 IQ plus

S 8000 IQ

S 9000
S 9000 plus

GEALAN-KUBUS®

S 9000 NL

Stulp

Sprossen

Glasleisten

Aussteifungen

Dichtungen

Rahmenverbreiterungen

Kopplungsprofile

Eckprofile

Verleistungen

Untere Anschlussprofile

Laibungsverkleidungen

GEALAN
HAFEN-CITY-FENSTER®

Schwellen

Lüftungssystem

Hebeschiebesysteme

Schiebesysteme

Rollladen

Klappladen

Scuro

Cassonetto

Sonstiges

Dichtungen · Gaskets

Glasdichtung · Glazing Gaskets

- S 7000 IQ
S 7000 IQ plus
- S 8000 IQ
- S 9000
S 9000 plus
- GEALAN-KUBUS®
- S 9000 NL
- Stulp
- Sprossen
- Glasleisten
- Aussteifungen

S 3000

-  3122 90 G
-  3123 90 G
-  3152 90 S/G ST
-  3153 90 S/G ST
-  3185 93 S/G
-  3167 92 S/G

S 7000 IQ / 7000 IQ plus

-  3122 90 G
-  3123 90 G
-  3152 90 S/G ST
-  3153 90 S/G ST
-  7151 90 S/G
-  6151 90 S/G
-  8156 92 S/G
-  8186 93 S/G
-  8619 90 S/G
-  2157 92 S/G

S 8000 IQ

-  3122 90 G
-  3123 90 G
-  3152 90 S/G ST
-  3153 90 S/G ST
-  8619 90 S/G
-  8186 93 S/G
-  8156 92 S/G
-  2157 92 S/G

S 9000

-  3122 90 G
-  3123 90 G
-  3152 90 S/G ST
-  3153 90 S/G ST
-  3167 92 S/G
-  6104 92 S/G
-  6106 90 S
-  2165 92 S/G

Anschlagdichtung · Rebate Seal

S 2000

-  2144 90 S
-  2149 90 S/G
-  3173 90 S
91 G

S 3000

-  2149 90 S/G
-  3173 90 S
91 G
-  3184 90 S/G
-  3185 93 S/G
-  8187 92 S/G

S 7000 IQ

-  2156 92 S/G

S 7000 IQ / 7000 IQ plus

-  7149 92 S/G
-  7157 90 S/G
-  7158 92 S/G
-  8150 90 S/G
-  2167 92 S/G
-  7159 90 S





S 8000 IQ

-  8186 93 S/G
-  3184 90 S/G
-  8150 90 S/G
-  8187 92 S/G
-  2143 92 S/G

S 9000

-  3167 92 S/G
-  3184 90 S/G
-  6101 92 S/G
-  8150 90 S/G
-  8187 92 S/G
-  2143 92 S/G

GEALAN-KUBUS®

-  5166 90 S
-  5164 92 S
-  5163 92 S
-  8187 92 S/G

- Dichtungen**
- Rahmenverbreiterungen
- Kopplungsprofile
- Eckprofile
- Verleistungen
- Untere Anschlussprofile
- Laibungsverkleidungen
- GEALAN
HAFEN-CITY-FENSTER®
- Schwellen
- Lüftungssystem
- Hebeschiebesysteme
- Schiebesysteme
- Rollladen
- Klappladen
- Scuro
- Cassonetto
- Sonstiges

Dichtungen · Gaskets Haustür · Front Door

S 3000

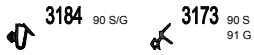

S 8000 IQ



S 9000

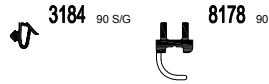

Falttür · Folding Door

S 8000 IQ / S 9000

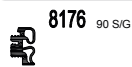

Bürstendichtungen · Brush Seals

Bürstendichtungen

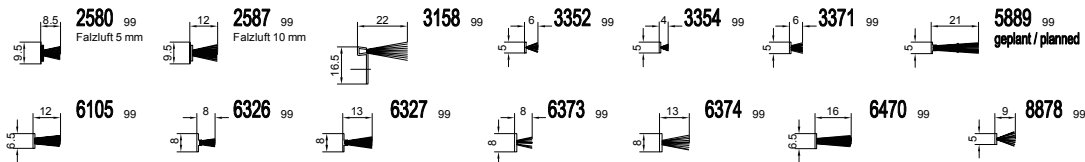

Dichtungen · Gaskets

Dichtungen

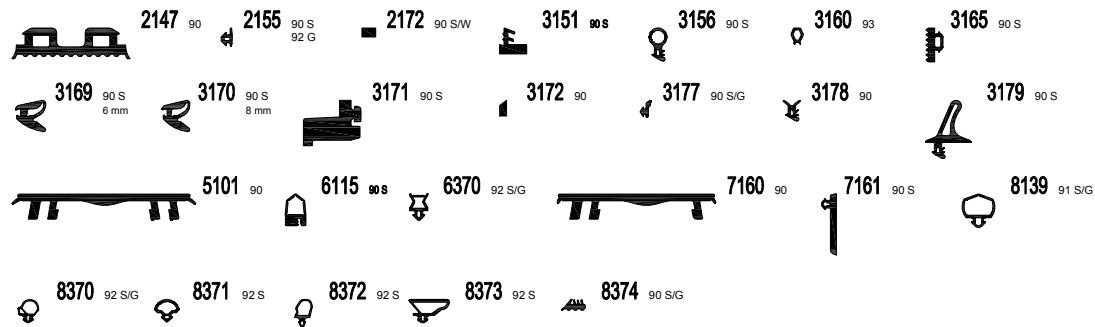

Klebeband · Tape

STV

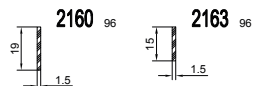

- S 7000 IQ
S 7000 IQ plus
- S 8000 IQ
- S 9000
S 9000 plus
- GEALAN-KUBUS*
- S 9000 NL
- Stulp
- Sprossen
- Glasleisten
- Aussteifungen

Dichtungen

- Rahmenverbreiterungen
- Kopplungsprofile
- Eckprofile
- Verleistungen
- Untere Anschlussprofile
- Laibungsverkleidungen
- GEALAN HAFEN-CITY-FENSTER®
- Schwellen
- Lüftungssystem
- Hebeschiebesysteme
- Schiebesysteme
- Rollladen
- Klappladen
- Scuro
- Cassonetto
- Sonstiges

Rahmenverbreiterungen · Frame Extensions

S 7000 IQ
S 7000 IQ plus

S 7000 IQ / S 8000 IQ / 3-Kammer

S 8000 IQ

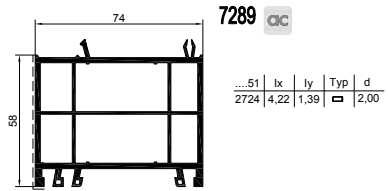
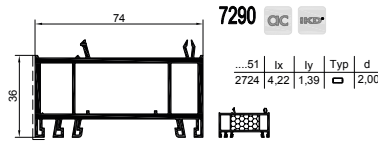
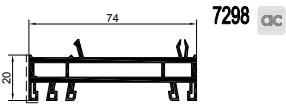

S 9000
S 9000 plus

GEALAN-KUBUS®

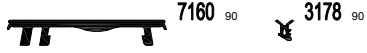

S 9000 NL

S 7000 IQ / S 8000 IQ / 5-Kammer

Stulp

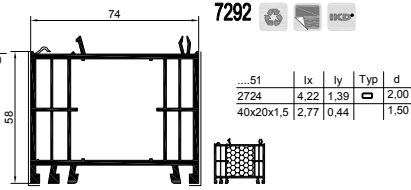
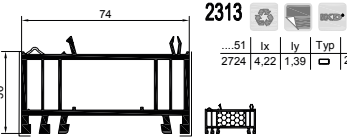
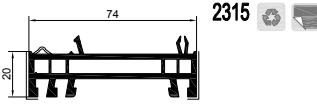

Sprossen

Glasleisten

Aussteifungen

Dichtungen

Rahmenverbreiterungen

Kopplungsprofile

Eckprofile

Verleistungen

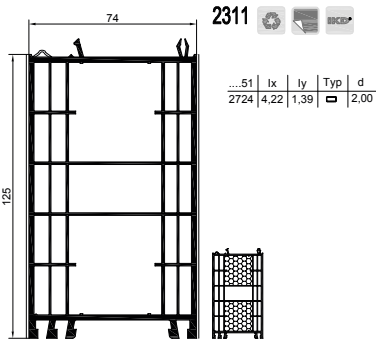

Untere Anschlussprofile

Laibungsverkleidungen

GEALAN
HAFEN-CITY-FENSTER®

Schwellen

Lüftungssystem

Hebeschiebesysteme

Schiebesysteme

Rollladen

Klappladen

Scuro

Cassonetto

Sonstiges

S 7000 IQ plus / S 9000 / S 9000 plus / GEALAN-KUBUS®

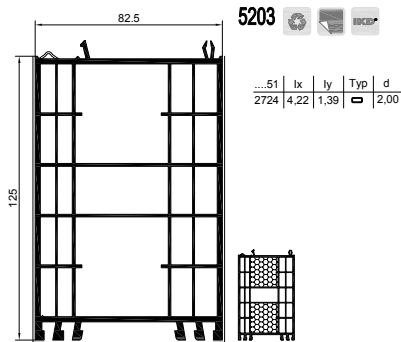
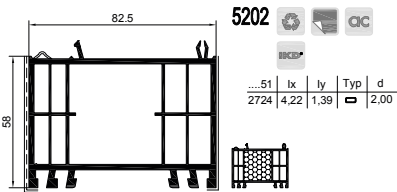
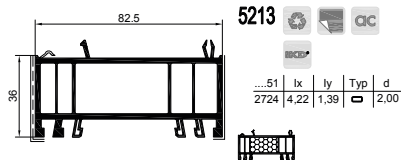
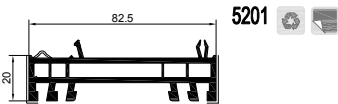

Kopplungsprofile · Coupling Profiles

System unabhängig

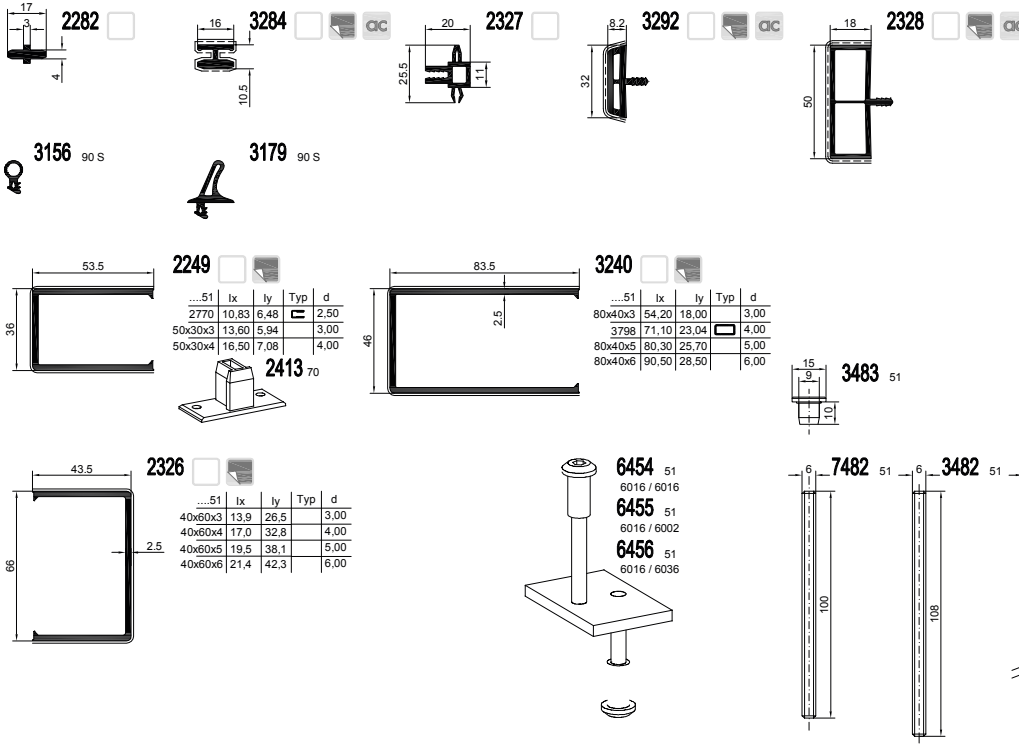

- S 7000 IQ
- S 7000 IQ plus
- S 8000 IQ
- S 9000
- S 9000 plus
- GEALAN-KUBUS*
- S 9000 NL
- Stulp
- Sprossen
- Glasleisten
- Aussteifungen
- Dichtungen
- Rahmenverbreiterungen

S 7000 IQ / S 8000 IQ

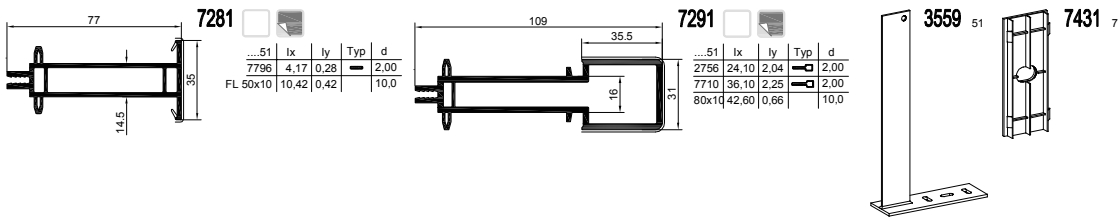

S 8000 IQ Brüstungsverglasung

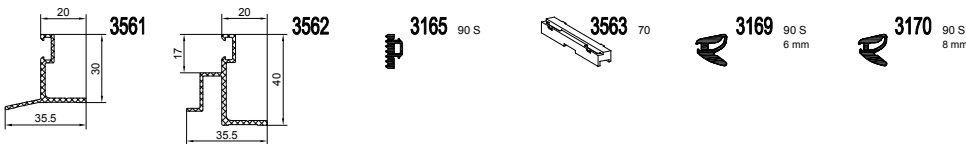

S 7000 IQ plus / S 9000 / S 9000 plus / GEALAN-KUBUS*

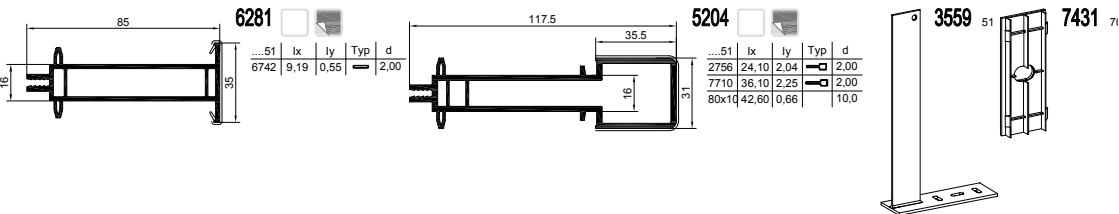

S 9000 / S 9000 NL Brüstungsverglasung

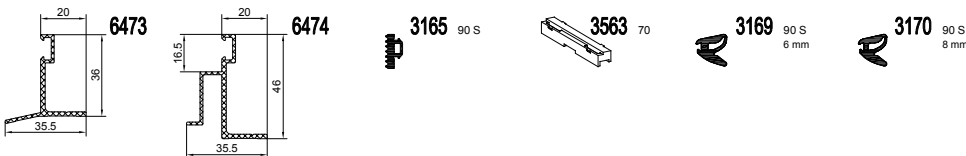

Kopplungsprofile

- Eckprofile
- Verleistungen
- Untere Anschlussprofile
- Laibungsverkleidungen
- GEALAN HAFEN-CITY-FENSTER®
- Schwellen
- Lüftungssystem
- Hebeschiebesysteme
- Schiebesysteme
- Rollladen
- Klappladen
- Scuro
- Cassonetto
- Sonstiges

Eckprofile · Corner Profiles

S 7000 IQ
S 7000 IQ plus

S 7000 IQ / S 8000 IQ

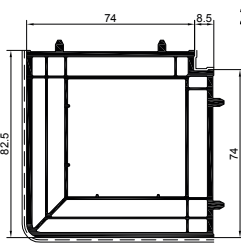

2304 

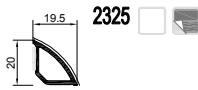

2325 

...51	lx	ly	Typ	d
7718	14,37	14,37	□	2,00
50x50x4	25,00	25,00	□	4,00
50x50x5	28,90	28,90	□	5,00

S 8000 IQ

S 9000
S 9000 plus

GEALAN-KUBUS*

S 9000 NL

Stulp

Sprossen

Glasleisten

Aussteifungen

Dichtungen

Rahmenverbreiterungen

Kopplungsprofile

Eckprofile

Verleistungen

Untere Anschlussprofile

Laibungsverkleidungen

GEALAN
HAFEN-CITY-FENSTER®

Schwellen

Lüftungssystem

Hebeschiebesysteme

Schiebesysteme

Rollladen

Klappladen

Scuro

Cassonetto

Sonstiges

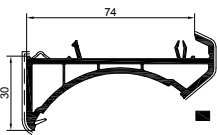

2234 

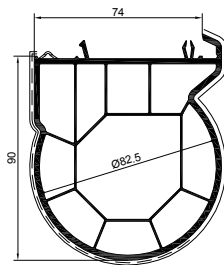

2233 

...51	lx	ly	Typ	d
2703	1,91	5,93	⌋	2,00
7711	7,54	7,54	○	2,60

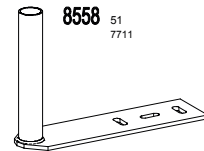

8558 51
7711

S 7000 IQ plus / S 9000 / S 9000 plus / GEALAN-KUBUS*

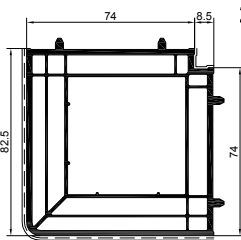

2304 

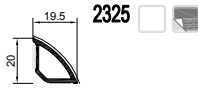

2325 

...51	lx	ly	Typ	d
7718	14,37	14,37	□	2,00
50x50x4	25,00	25,00	□	4,00
50x50x5	28,90	28,90	□	5,00

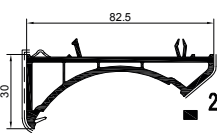

5207 

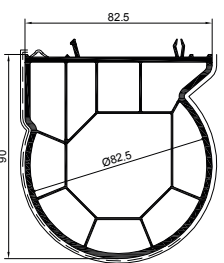

5206 

...51	lx	ly	Typ	d
2703	1,91	5,93	⌋	2,00
7711	7,54	7,54	○	2,60

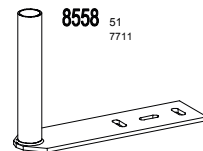

8558 51
7711

Verleistungen · Casing Profiles

System unabhängig

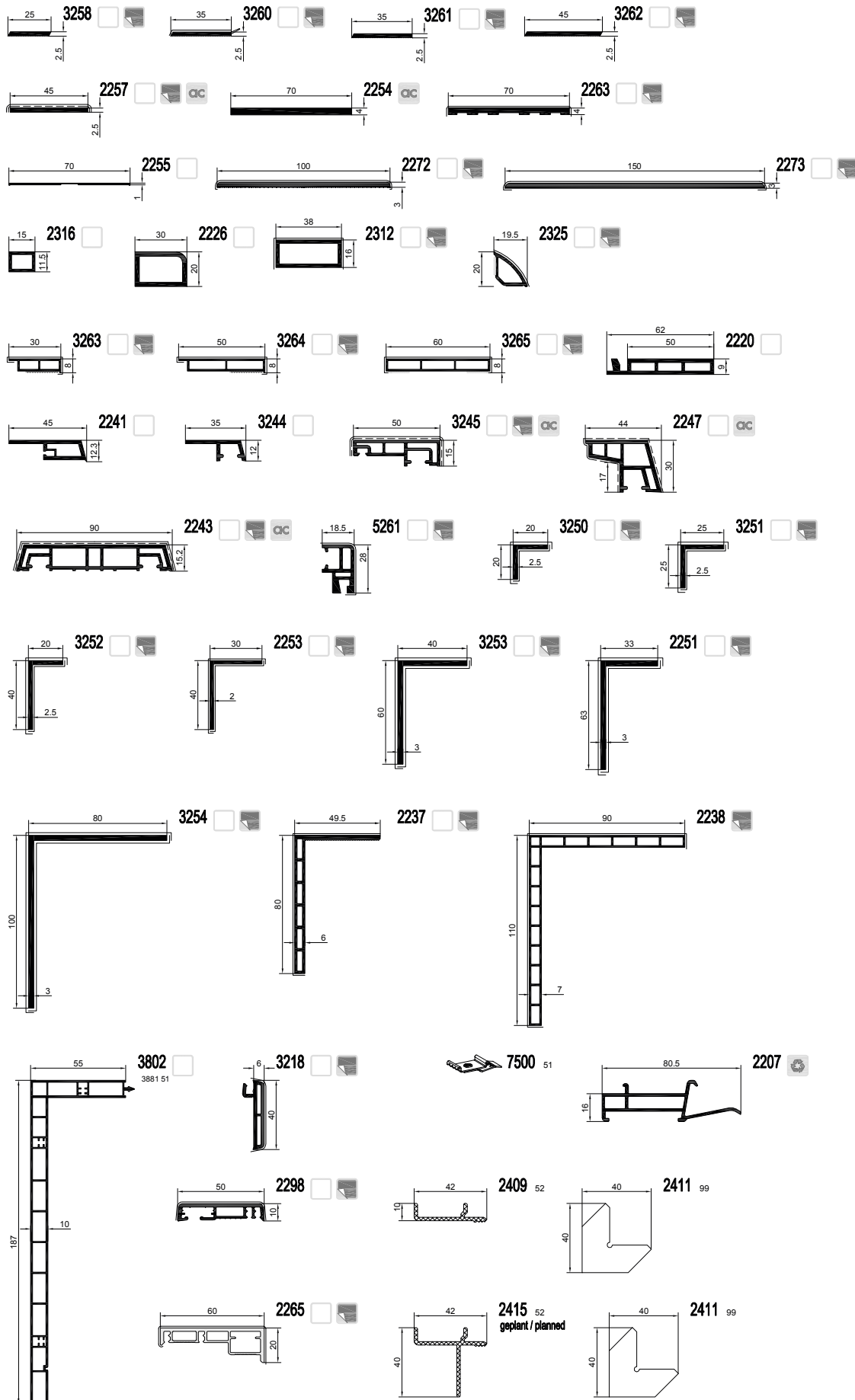

S 7000 IQ
S 7000 IQ plus

S 8000 IQ

S 9000
S 9000 plus

GEALAN-KUBUS*

S 9000 NL

Stulp

Sprossen

Glasleisten

Aussteifungen

Dichtungen

Rahmenverbreiterungen

Kopplungsprofile

Eckprofile

Verleistungen

Untere Anschlussprofile

Laibungsverkleidungen

GEALAN
HAFEN-CITY-FENSTER®

Schwellen

Lüftungssystem

Hebeschiesesysteme

Schiebesysteme

Rollladen

Klappläden

Scuro

Cassonetto

Sonstiges

Untere Anschlussprofile · Sill Profiles

- S 7000 IQ
S 7000 IQ plus
- S 8000 IQ
- S 9000
S 9000 plus
- GEALAN-KUBUS®
- S 9000 NL
- Stulp
- Sprossen
- Glasleisten
- Aussteifungen
- Dichtungen
- Rahmenverbreiterungen
- Kopplungsprofile
- Eckprofile
- Verleistungen

System unabhängig

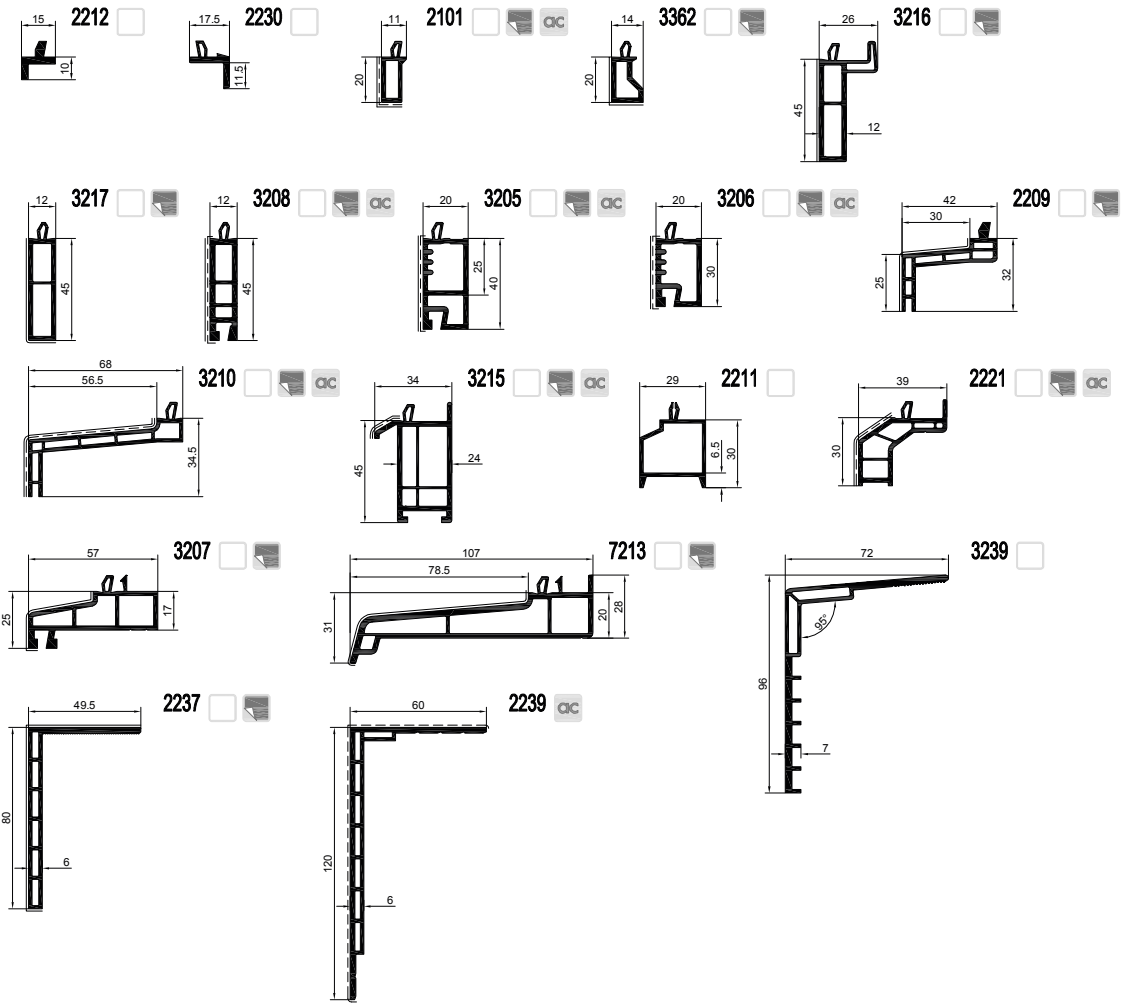

Untere Anschlussprofile

- Laibungsverkleidungen
- GEALAN
HAFEN-CITY-FENSTER®
- Schwellen
- Lüftungssystem
- Hebeschiebesysteme
- Schiebesysteme
- Rollladen
- Klappladen
- Scuro
- Cassonetto
- Sonstiges

S 7000 IQ / S 8000 IQ

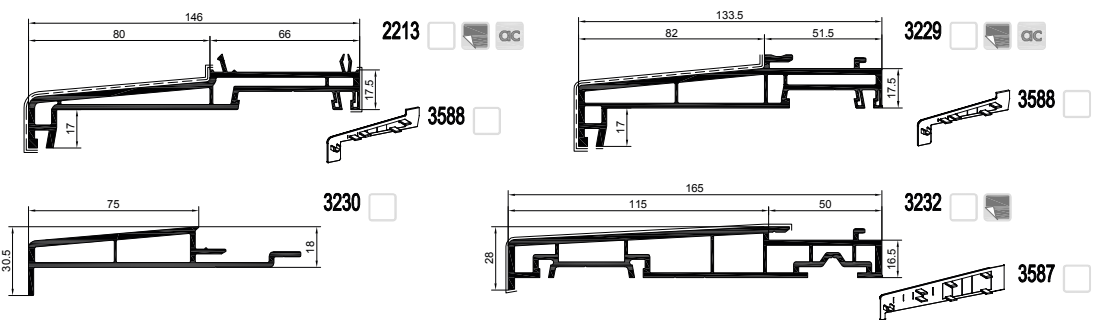

S 8000 IQ

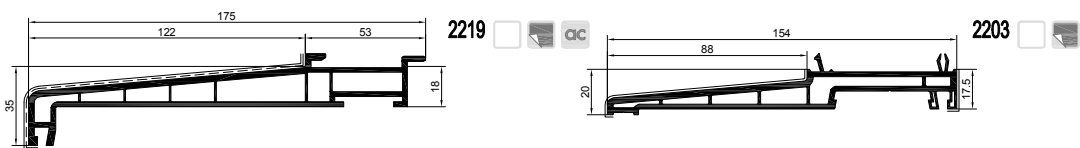

Untere Anschlussprofile · Sill Profiles

S 7000 IQ / S 8000 IQ / S 7000 IQ plus / S 9000 / S 9000 plus / GEALAN-KUBUS

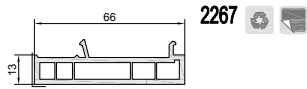

2267

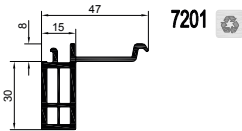

7201

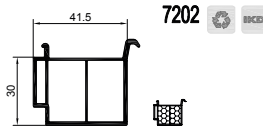

7202

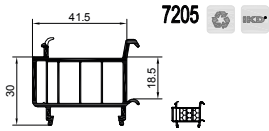

7205

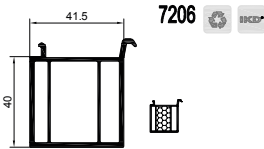

7206

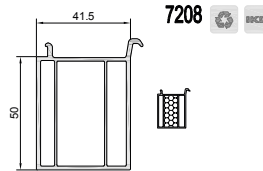

7208

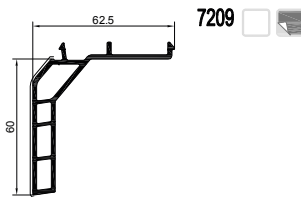

7209

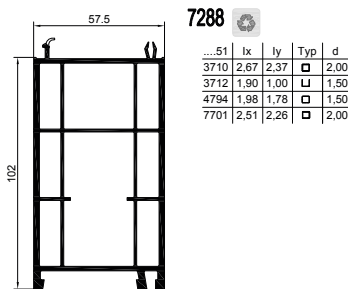

7288

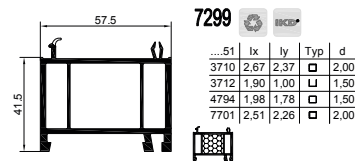

7299

...	51	lx	ly	Typ	d
3710	2,67	2,37	□	2,00	
3712	1,90	1,00	└	1,50	
4794	1,98	1,78	□	1,50	
7701	2,51	2,26	□	2,00	

...	51	lx	ly	Typ	d
3710	2,67	2,37	□	2,00	
3712	1,90	1,00	└	1,50	
4794	1,98	1,78	□	1,50	
7701	2,51	2,26	□	2,00	

S 7000 IQ
S 7000 IQ plus

S 8000 IQ

S 9000
S 9000 plus

GEALAN-KUBUS*

S 9000 NL

Stulp

Sprossen

Glasleisten

Aussteifungen

Dichtungen

Rahmenverbreiterungen

Kopplungsprofile

Eckprofile

Verleistungen

Untere Anschlussprofile

Laibungsverkleidungen

GEALAN
HAFEN-CITY-FENSTER®

Schwellen

Lüftungssystem

Hebeschiebesysteme

Schiebesysteme

Rollladen

Klappläden

Scuro

Cassonetto

Sonstiges

S 7000 IQ plus / S 9000 / S 9000 plus / GEALAN-KUBUS*

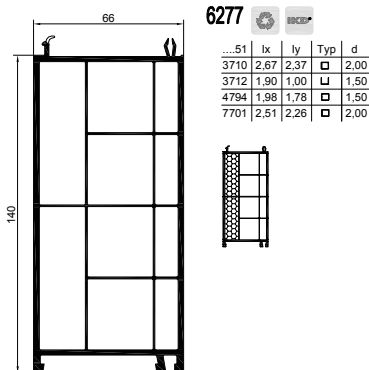

6277

...	51	lx	ly	Typ	d
3710	2,67	2,37	□	2,00	
3712	1,90	1,00	└	1,50	
4794	1,98	1,78	□	1,50	
7701	2,51	2,26	□	2,00	

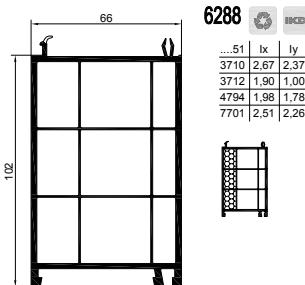

6288

...	51	lx	ly	Typ	d
3710	2,67	2,37	□	2,00	
3712	1,90	1,00	└	1,50	
4794	1,98	1,78	□	1,50	
7701	2,51	2,26	□	2,00	

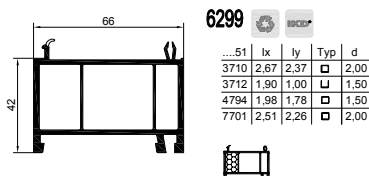

6299

...	51	lx	ly	Typ	d
3710	2,67	2,37	□	2,00	
3712	1,90	1,00	└	1,50	
4794	1,98	1,78	□	1,50	
7701	2,51	2,26	□	2,00	

Laibungsverkleidungen · Casing

System unabhängig

S 7000 IQ
S 7000 IQ plus

S 8000 IQ

S 9000
S 9000 plus

GEALAN-KUBUS®

S 9000 NL

Stulp

Sprossen

Glasleisten

Aussteifungen

Dichtungen

Rahmenverbreiterungen

Kopplungsprofile

Eckprofile

Verleistungen

Untere Anschlussprofile

Laibungsverkleidungen

GEALAN
HAFEN-CITY-FENSTER®

Schwellen

Lüftungssystem

Hebeschiebesysteme

Schiebesysteme

Rollladen

Klappladen

Scuro

Cassonetto

Sonstiges

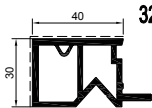

3271 Export

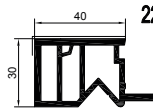

2271 Export

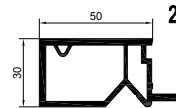

2270 Export

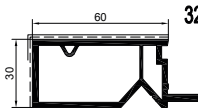

3270 Export

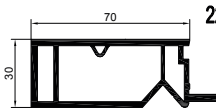

2269 Export

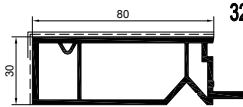

3269 Export

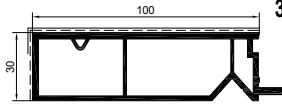

3268 Export

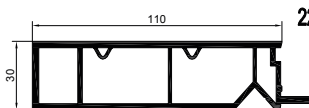

2268 Export



2266 Export

GEALAN HAFEN-CITY-FENSTER®

System unabhängig

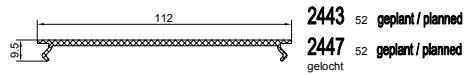
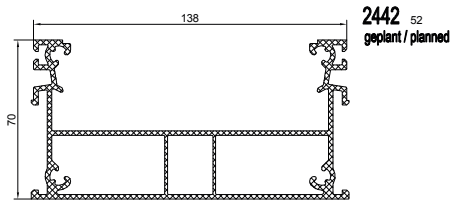

2444 90 S
geplamt / planned

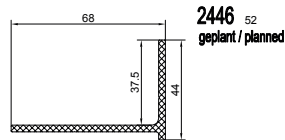
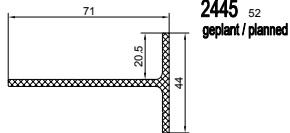

S 7000 IQ
S 7000 IQ plus

S 8000 IQ

S 9000
S 9000 plus

GEALAN-KUBUS®

S 9000 NL

Stulp

Sprossen

Glasleisten

Aussteifungen

Dichtungen

Rahmenverbreiterungen

Kopplungsprofile

Eckprofile

Verleistungen

Untere Anschlussprofile

Laibungsverkleidungen

**GEALAN
HAFEN-CITY-FENSTER®**

Schwellen

Lüftungssystem

Hebeschiebesysteme

Schiebesysteme

Rollladen

Klappläden

Scuro

Cassonetto

Sonstiges

Schwellen · Thresholds

System unabhängig

S 7000 IQ
S 7000 IQ plus

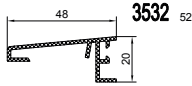

S 8000 IQ

S 9000
S 9000 plus

S 7000 IQ

GEALAN-KUBUS®

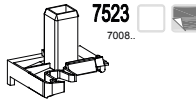
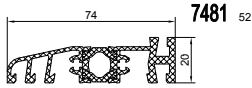

S 9000 NL

Stulp

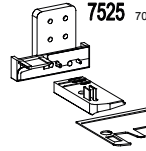
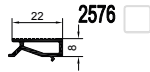
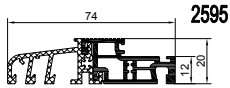

Sprossen

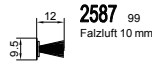

Glasleisten

Aussteifungen

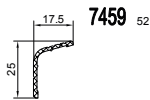
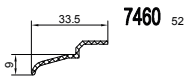

Dichtungen

Rahmenverbreiterungen

S 8000 IQ

Kopplungsprofile

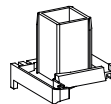
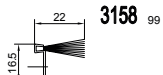
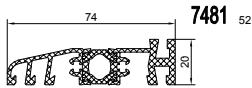

8521

8010..

8522

8006..

8523

8012..

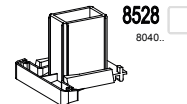

8528

8040..

Eckprofile

Verleistungen

Untere Anschlussprofile

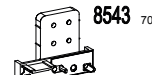
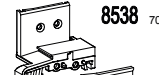
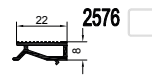
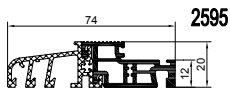

Laibungsverkleidungen

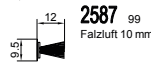
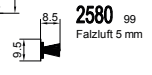

GEALAN
HAFEN-CITY-FENSTER®

Schwellen

Lüftungssystem

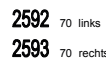
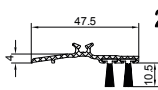

8551
geplant / planned

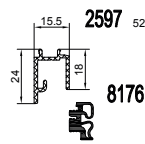

8176
90 S/G

Hebeschiebesysteme

Schiebesysteme

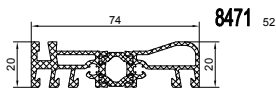

Rollladen

Klappladen

Scuro

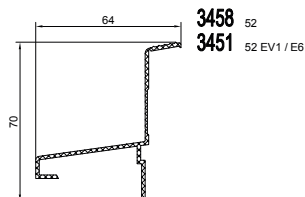
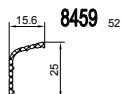

Cassonetto

Sonstiges

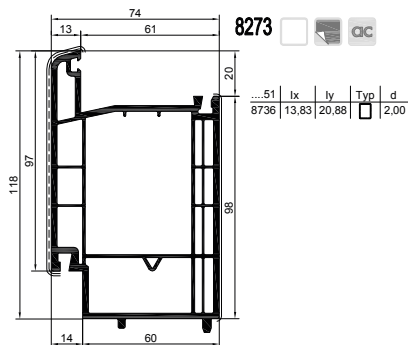

Schwellen · Thresholds

S 8000 IQ

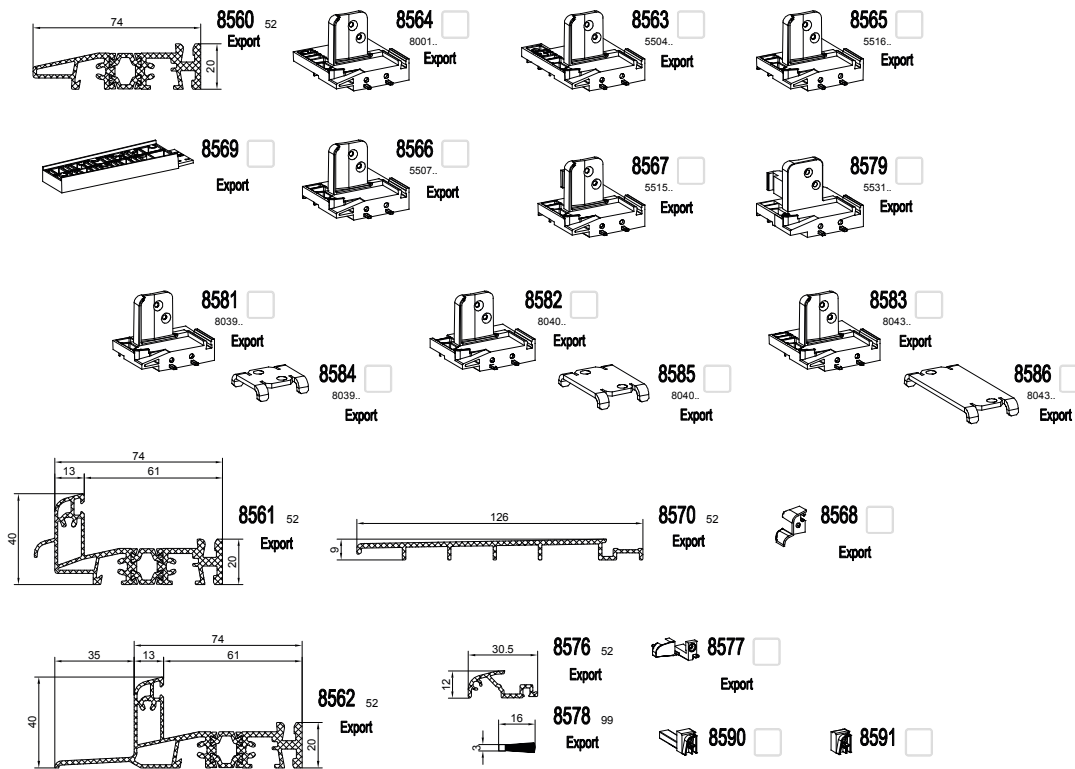

S 7000 IQ plus

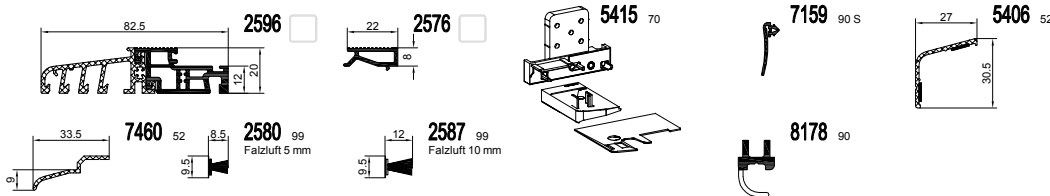

S 9000 / S 9000 plus

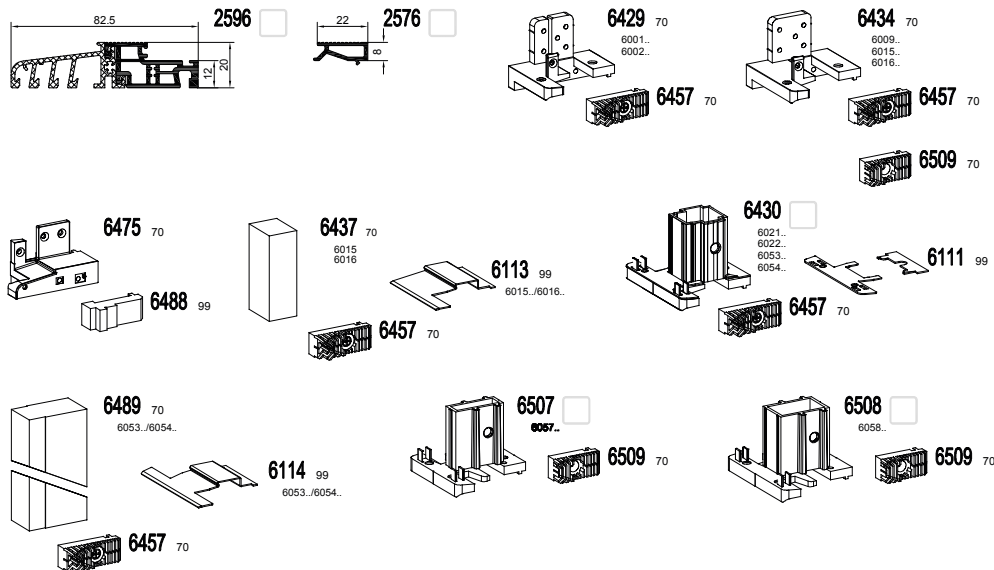

S 7000 IQ
S 7000 IQ plus

S 8000 IQ

S 9000
S 9000 plus

GEALAN-KUBUS®

S 9000 NL

Stulp

Sprossen

Glasleisten

Aussteifungen

Dichtungen

Rahmenverbreiterungen

Kopplungsprofile

Eckprofile

Verleistungen

Untere Anschlussprofile

Laibungsverkleidungen

GEALAN
HAFEN-CITY-FENSTER®

Schwellen

Lüftungssystem

Hebeschiebesysteme

Schiebesysteme

Rollladen

Klappladen

Scuro

Cassonetto

Sonstiges

Schwellen · Thresholds

S 7000 IQ
S 7000 IQ plus

S 9000 / S 9000 plus

S 8000 IQ

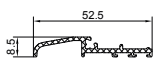

6431 52



6432 70 rechts
6012



6433 70
6431



6469 70
6029



6447 70
Aluschale



6491 70
6039

S 9000
S 9000 plus

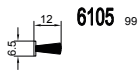

6105 99



6450 70 rechts
6020

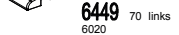

6449 70 links
6020

GEALAN-KUBUS®

S 9000 NL

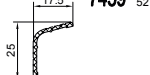

7459 52

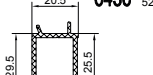

6436 52



8178 90

Stulp



8176 90 S/G

Sprossen

Glasleisten

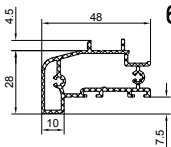

6463 52

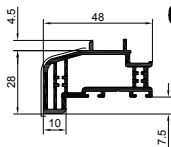

6463

...	52	lx	ly	Typ	d
	6791	0,71	0,23	Typ	1,50



6464 39
6463

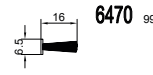

6470 99

Aussteifungen

Dichtungen

Rahmenverbreiterungen

GEALAN-KUBUS®

Kopplungsprofile

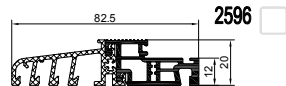

2596

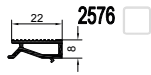

2576

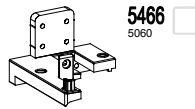

5466 5060

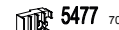

5477 70

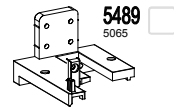

5489 5065

Eckprofile

Verleistungen

Untere Anschlussprofile

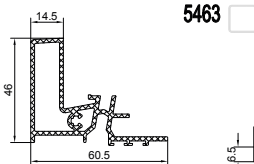

5463



5464

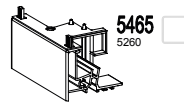

5465 5260
5260



5479 70

Laibungsverkleidungen



6105 99

GEALAN
HAFEN-CITY-FENSTER®

Schwellen

Lüftungssystem

Hebeschiebesysteme

Schiebesysteme

Rollladen

Klappladen

Scuro

Cassonetto

Sonstiges

Lüftungssystem · Ventilation System

GECCO 2

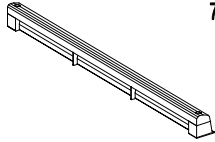

7401 52
S 7000 IQ
S 7000 IQ plus

GECCO 3

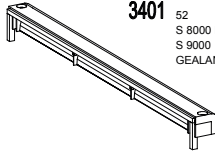

3401 52
S 8000 IQ
S 9000
GEALAN-KUBUS®

GECCO 4

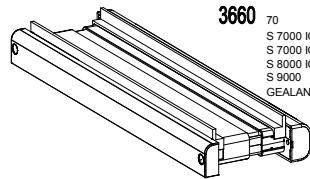

3660 70
S 7000 IQ
S 7000 IQ plus
S 8000 IQ
S 9000
GEALAN-KUBUS®

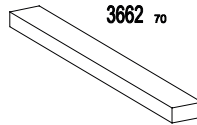

3662 70

Air Watch



3400 99

S 7000 IQ
S 7000 IQ plus

S 8000 IQ

S 9000
S 9000 plus

GEALAN-KUBUS®

S 9000 NL

Stulp

Sprossen

Glasleisten

Aussteifungen

Dichtungen

Rahmenverbreiterungen

Kopplungsprofile

Eckprofile

Verleistungen

Untere Anschlussprofile

Laibungsverkleidungen

GEALAN
HAFEN-CITY-FENSTER®

Schwellen

Lüftungssystem

Hebeschiebesysteme

Schiebesysteme

Rollladen

Klappläden

Scuro

Cassonetto

Sonstiges

Hebeschiebesysteme · Lift-Slide systems

S 7000 IQ
S 7000 IQ plus

S 8000 IQ

S 8000 IQ

S 9000
S 9000 plus

GEALAN-KUBUS®

S 9000 NL

Stulp

Sprossen

Glasleisten

Aussteifungen

Dichtungen

Rahmenverbreiterungen

Kopplungsprofile

Eckprofile

Verleistungen

Untere Anschlussprofile

Laibungsverkleidungen

GEALAN
HAFEN-CITY-FENSTER®

Schwellen

Lüftungssystem

Hebeschiebesysteme

Schiebesysteme

Rollladen

Klappladen

Scuro

Cassonetto

Sonstiges

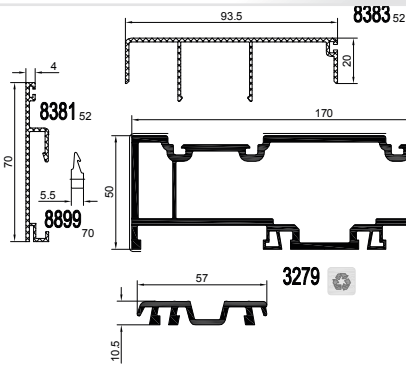

8360

...	.51	lx	ly	Typ	d
8391	12,8	2,74		□	1,50
...	.52	lx	ly	Typ	d
8390	186,7	17,74		□	3,00

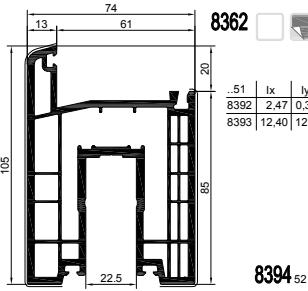
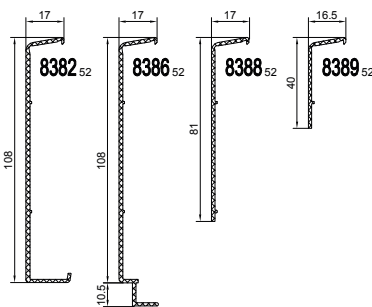
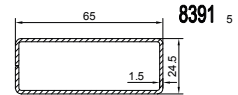
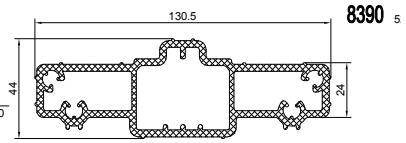

...	.51	lx	ly	Typ	d
8392	2,47	0,34		□	1,50
8393	12,40	12,2		□	2,00

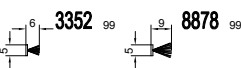
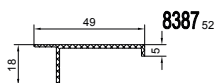
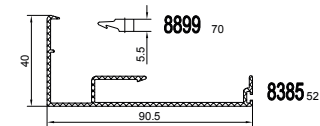
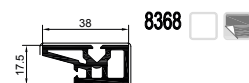
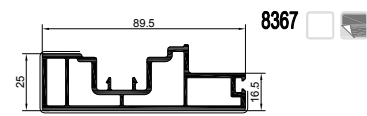
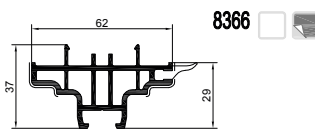
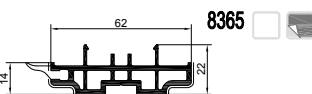
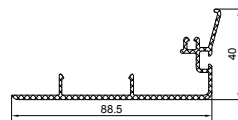
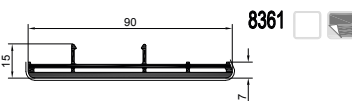
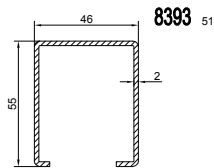
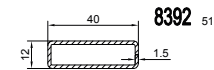

S 8000 IQ Zubehör Zarge umlaufend

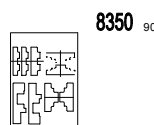
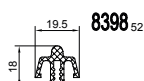
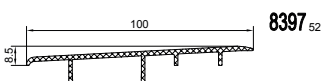

Hebeschiebesysteme · Lift-Slide systems

S 9000

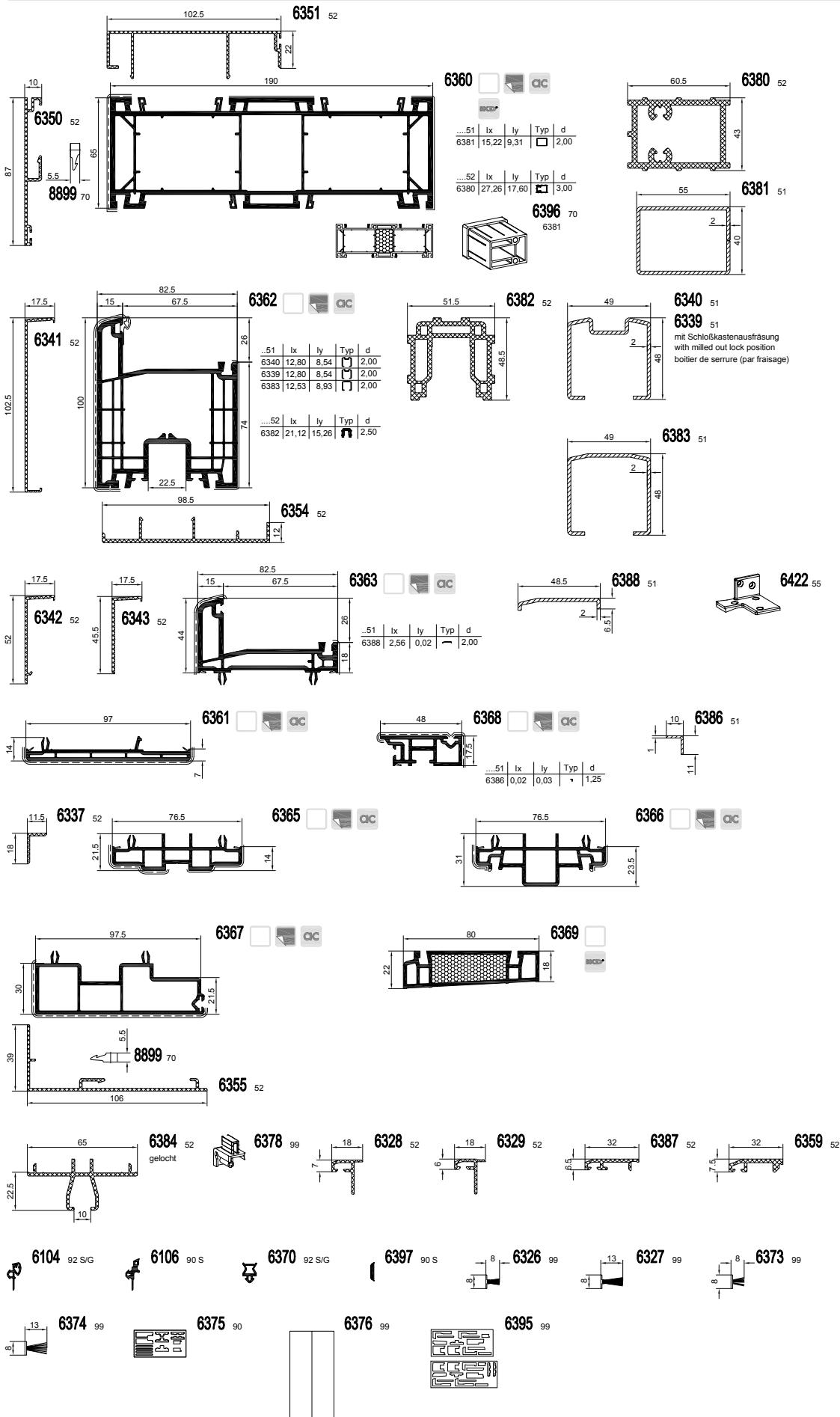

S 7000 IQ
S 7000 IQ plus

S 8000 IQ

S 9000
S 9000 plus

GEALAN-KUBUS®

S 9000 NL

Stulp

Sprossen

Glasleisten

Aussteifungen

Dichtungen

Rahmenverbreiterungen

Kopplungsprofile

Eckprofile

Verleistungen

Untere Anschlussprofile

Laibungsverkleidungen

GEALAN
HAFEN-CITY-FENSTER®

Schwellen

Lüftungssystem

Hebeschiebesysteme

Schiebesysteme

Rollladen

Klappladen

Scuro

Cassonetto

Sonstiges

Hebeschiebesysteme · Lift-Slide systems

S 7000 IQ
S 7000 IQ plus

S 9000



6330⁸⁹



6338⁹⁹



6345⁹⁹



6347⁹⁹



6348⁷⁰



6349⁹⁹
6387

S 8000 IQ

S 9000
S 9000 plus



6358⁷⁰

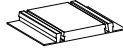

6377⁹²



6398⁹⁹



6399⁹⁹

GEALAN-KUBUS®

S 9000 NL

Stulp

Sprossen

S 9000 Zubehör Zarge umlaufend

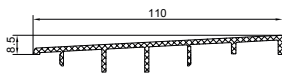

6390⁵²



8398⁵²

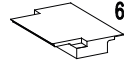

6331⁹⁹

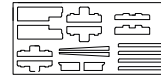

6391⁹⁹

Glasleisten

Aussteifungen

Dichtungen

Rahmenverbreiterungen

Kopplungsprofile

Eckprofile

Verleistungen

Untere Anschlussprofile

Laibungsverkleidungen

GEALAN
HAFEN-CITY-FENSTER®

Schwellen

Lüftungssystem

Hebeschiebesysteme

Schiebesysteme

Rollladen

Klappladen

Scuro

Cassonetto

Sonstiges

SF Schiebefenster · Sliding Window

Schiebefenster

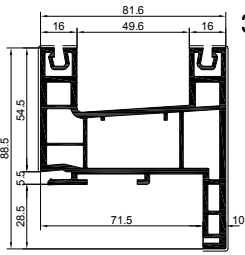

3029

...51	lx	ly	Typ	d
2724	4,46	1,44	□	2,00

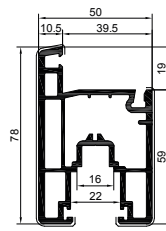
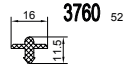

3083

...51	lx	ly	Typ	d
3762	1,74	0,93	□	2,00
3763	3,23	1,98	□	2,00

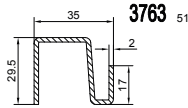
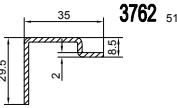
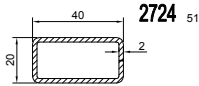
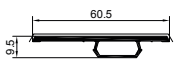

Schiebesystem 48 / 74 mm

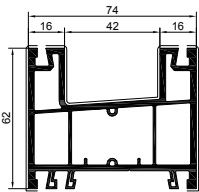

5802

...51	lx	ly	Typ	d
5832	2,60	0,54	□	2,00

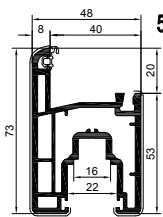
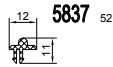

5803

...51	lx	ly	Typ	d
5833	3,28	2,11	□	2,00
5834	1,54	1,38	□	2,00

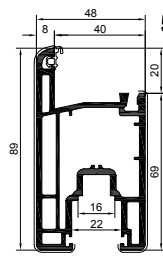

5805

...51	lx	ly	Typ	d
5836	1,73	4,09	□	2,00
5854	4,00	4,58	□	2,00

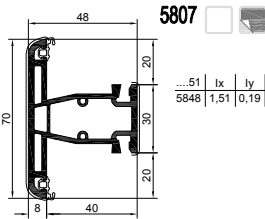

5807

...51	lx	ly	Typ	d
5848	1,51	0,19	□	1,50

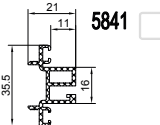
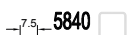
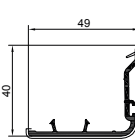
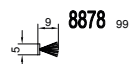
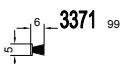
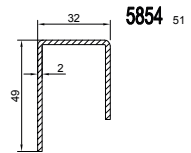
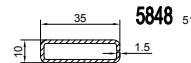
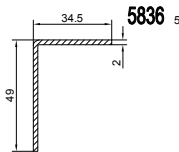
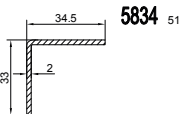
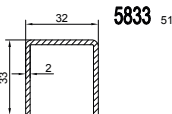
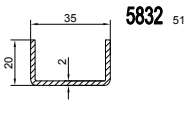

S 7000 IQ
S 7000 IQ plus

S 8000 IQ

S 9000
S 9000 plus

GEALAN-KUBUS®

S 9000 NL

Stulp

Sprossen

Glasleisten

Aussteifungen

Dichtungen

Rahmenverbreiterungen

Kopplungsprofile

Eckprofile

Verleistungen

Untere Anschlussprofile

Laibungsverkleidungen

GEALAN
HAFEN-CITY-FENSTER®

Schwellen

Lüftungssystem

Hebeschiebesysteme

Schiebesysteme

Rollladen

Klappladen

Scuro

Cassonetto

Sonstiges

GEALAN-Schiebesystem · GEALAN-Sliding System

Schiebesystem 74 / 150 mm

S 7000 IQ
S 7000 IQ plus

S 8000 IQ

S 9000
S 9000 plus

GEALAN-KUBUS®

S 9000 NL

Stulp

Sprossen

Glasleisten

Aussteifungen

Dichtungen

Rahmenverbreiterungen

Kopplungsprofile

Eckprofile

Verleistungen

Untere Anschlussprofile

Laibungsverkleidungen

GEALAN
HAFEN-CITY-FENSTER®

Schwellen

Lüftungssystem

Hebeschiebesysteme

Schiebesysteme

Rollladen

Klappläden

Scuro

Cassonetto

Sonstiges

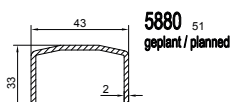
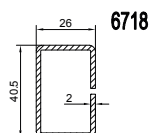
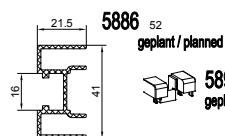
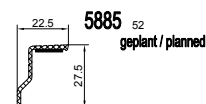
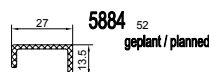
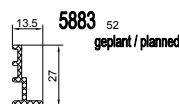
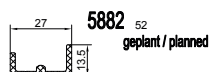
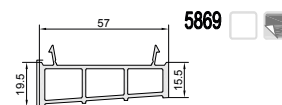
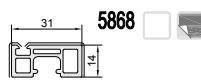
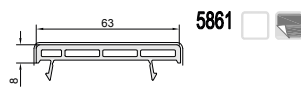
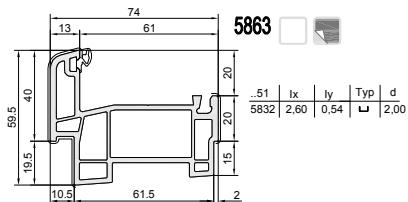
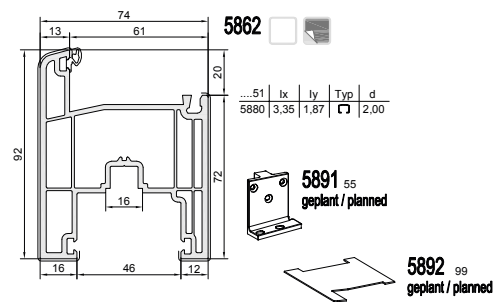
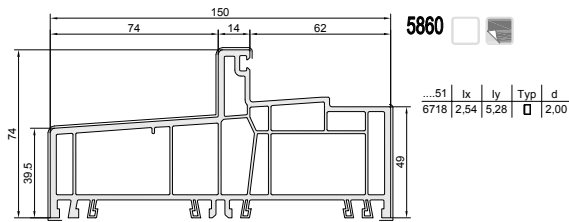

Rollladen · Roller Shutter

Rollladen

3347 **3429**
 Dimensions: 64, 8, 18, 41, 15, 1.5

3348 **3434** **3349** **3434**
 Dimensions: 50, 8, 18, 41, 15, 1.5
 *

3350 **3351** **3438** **3439** **3440**
 Dimensions: 37.5, 11, 17, 48, 20
 *

2224 **2421** **2421** **2424**
 Dimensions: 37.5, 10, 18, 48, 20
 geplamt / planned

2275 **2421** **2424**
 Dimensions: 58, 10, 18, 48, 20
 geplamt / planned

2276 **2423**
 Dimensions: 64, 10, 18, 48, 20
 geplamt / planned

2225 **2312** **3406** ⁷⁰ **3354** ⁹⁹ **3352** ⁹⁹ **8878** ⁹⁹
 Dimensions: 17.5, 37.5, 48.5, 90, 55, 40.5, 57, 44, 24, 10.5, 4, 6, 9

2503 ⁵² **3355** **3436**
 Dimensions: 30, 18.5, 18.5, 43.5, 16
 gelocht
 *

3356 **3357**
 Dimensions: 30, 16, 30, 12
 *

3815
 Dimensions: 62, 10, 11, 41, 20
 *

* Bereinigung geplant

- S 7000 IQ
S 7000 IQ plus
- S 8000 IQ
- S 9000
S 9000 plus
- GEALAN-KUBUS®
- S 9000 NL
- Stulp
- Sprossen
- Glasleisten
- Aussteifungen
- Dichtungen
- Rahmenverbreiterungen
- Kopplungsprofile
- Eckprofile
- Verleistungen
- Untere Anschlussprofile
- Laibungsverkleidungen
- GEALAN
HAFEN-CITY-FENSTER®
- Schwellen
- Lüftungssystem
- Hebeschiesesysteme
- Schiebesysteme
- Rollladen**
- Klappladen
- Scuro
- Cassonetto
- Sonstiges

Rollladen · Roller Shutter

- S 7000 IQ
S 7000 IQ plus
- S 8000 IQ
- S 9000
S 9000 plus
- GEALAN-KUBUS®
- S 9000 NL
- Stulp
- Sprossen
- Glasleisten
- Aussteifungen
- Dichtungen
- Rahmenverbreiterungen
- Kopplungsprofile
- Eckprofile
- Verleistungen
- Untere Anschlussprofile
- Laibungsverkleidungen
- GEALAN
HAFEN-CITY-FENSTER®
- Schwellen
- Lüftungssystem
- Hebeschiebesysteme
- Schiebesysteme
- Rollladen**
- Klappladen
- Scuro
- Cassonetto
- Sonstiges

Rollladen

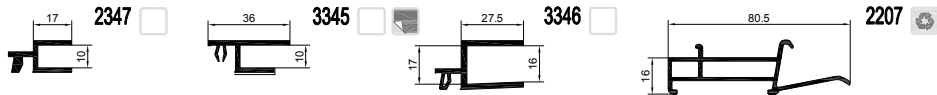

für 3347, 3348 und 3349

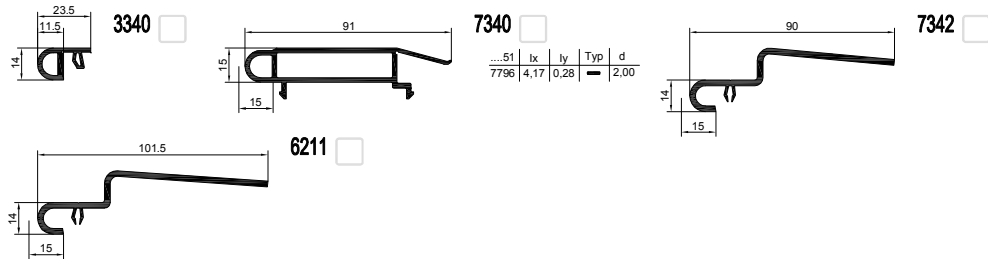

für 3355, 3350 und 3351

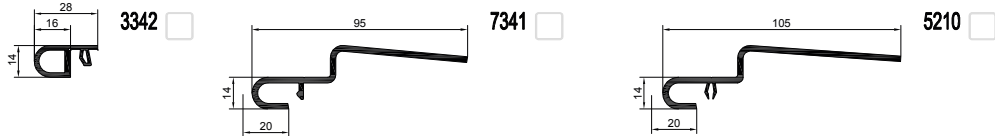

Rollladen Südeuropa

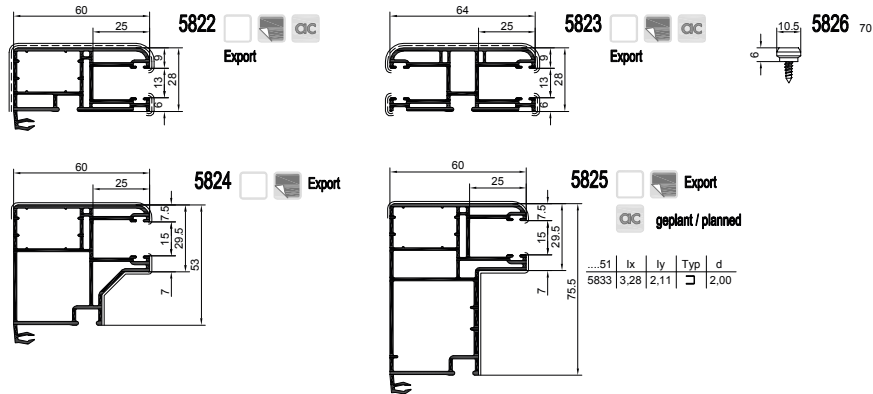

Klappladen · Folding Shutter

Klappladen

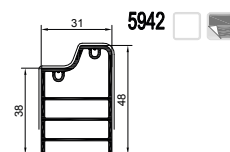
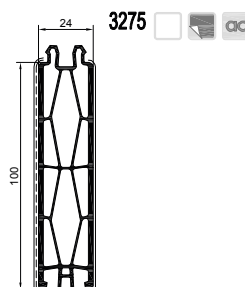
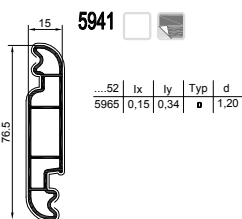
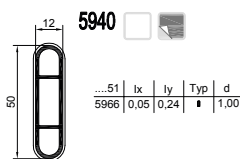
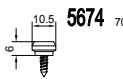
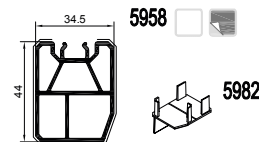
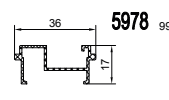
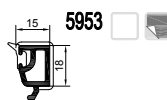
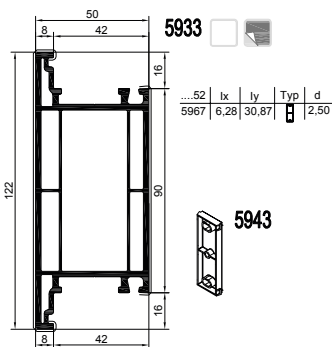
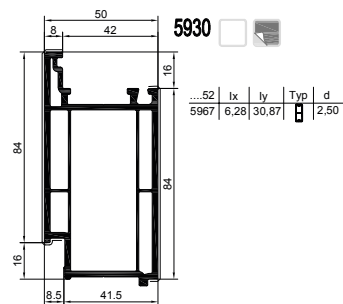
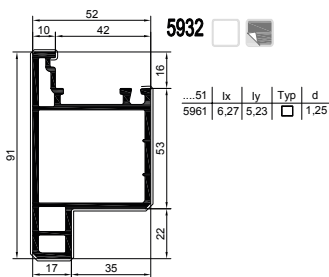
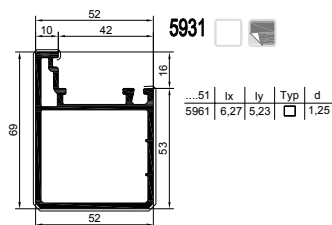
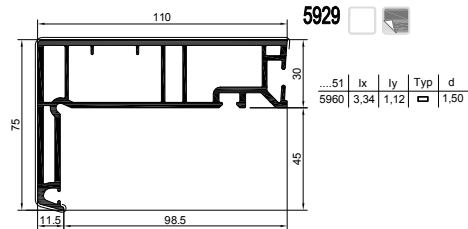
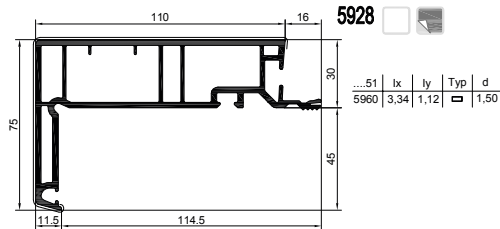
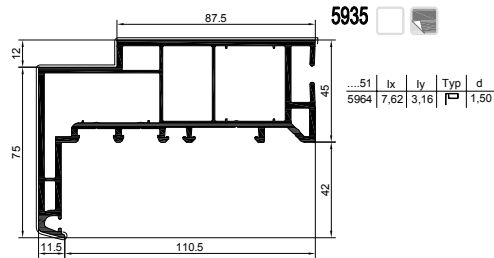
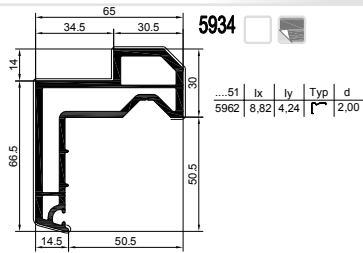

S 7000 IQ
S 7000 IQ plus

S 8000 IQ

S 9000
S 9000 plus

GEALAN-KUBUS®

S 9000 NL

Stulp

Sprossen

Glasleisten

Aussteifungen

Dichtungen

Rahmenverbreiterungen

Kopplungsprofile

Eckprofile

Verleistungen

Untere Anschlussprofile

Laibungsverkleidungen

GEALAN
HAFEN-CITY-FENSTER®

Schwellen

Lüftungssystem

Hebeschiebesysteme

Schiebesysteme

Rollladen

Klappladen

Scuro

Cassonetto

Sonstiges

Klappladen · Folding Shutter

Klappladen

S 7000 IQ
S 7000 IQ plus

S 8000 IQ

S 9000
S 9000 plus

GEALAN-KUBUS®

S 9000 NL

Stulp

Sprossen

Glasleisten

Aussteifungen

Dichtungen

Rahmenverbreiterungen

Kopplungsprofile

Eckprofile

Verleistungen

Untere Anschlussprofile

Laibungsverkleidungen

GEALAN
HAFEN-CITY-FENSTER®

Schwellen

Lüftungssystem

Hebeschiebesysteme

Schiebesysteme

Rollladen

Klappladen

Scuro

Cassonetto

Sonstiges

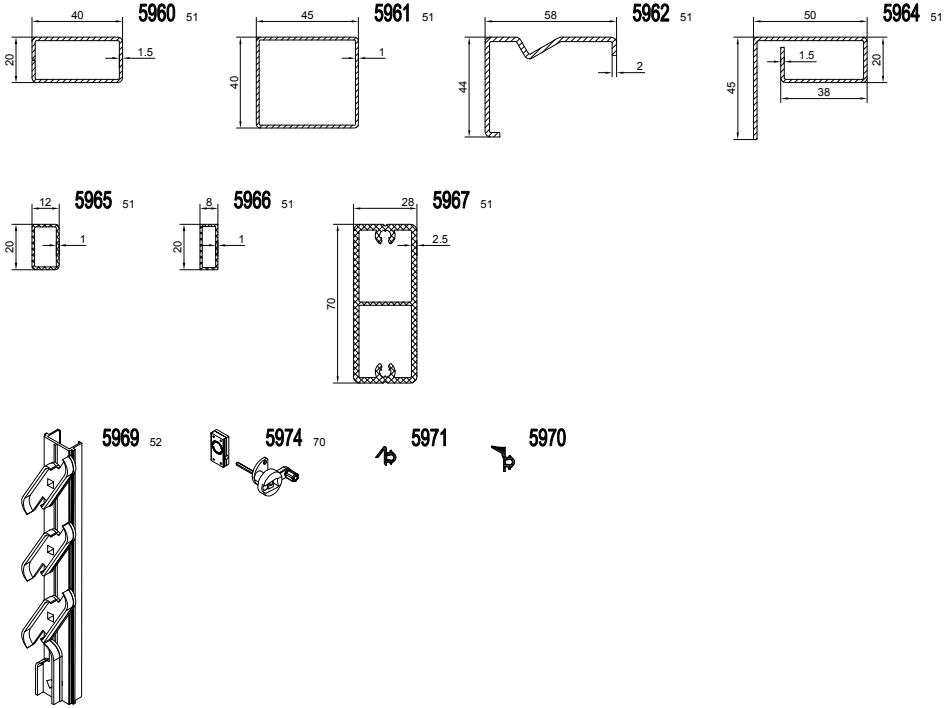

Scuro

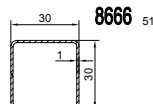
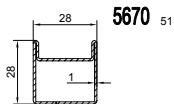
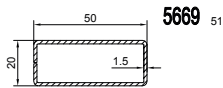
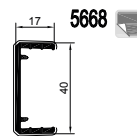
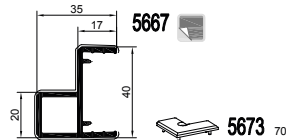
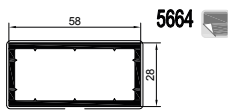
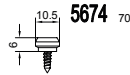
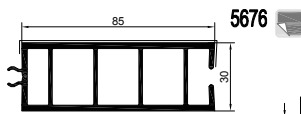
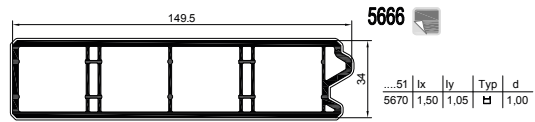
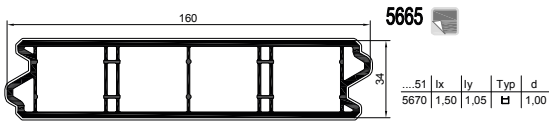
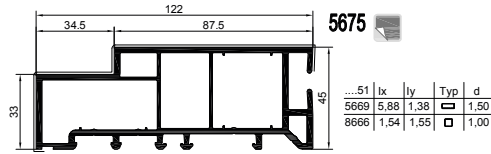
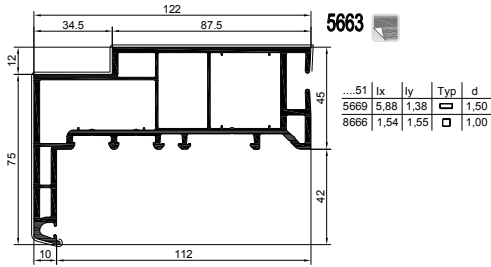

S 7000 IQ
S 7000 IQ plus

S 8000 IQ

S 9000
S 9000 plus

GEALAN-KUBUS*

S 9000 NL

Stulp

Sprossen

Glasleisten

Aussteifungen

Dichtungen

Rahmenverbreiterungen

Kopplungsprofile

Eckprofile

Verleistungen

Untere Anschlussprofile

Laibungsverkleidungen

GEALAN
HAFEN-CITY-FENSTER®

Schwellen

Lüftungssystem

Hebeschiebesysteme

Schiebesysteme

Rollladen

Klappläden

Scuro

Cassonetto

Sonstiges

Cassonetto · Roller Shutter

Cassonetto

S 7000 IQ
S 7000 IQ plus

S 8000 IQ

S 9000
S 9000 plus

GEALAN-KUBUS®

S 9000 NL

Stulp

Sprossen

Glasleisten

Aussteifungen

Dichtungen

Rahmenverbreiterungen

Kopplungsprofile

Eckprofile

Verleistungen

Untere Anschlussprofile

Laibungsverkleidungen

GEALAN
HAFEN-CITY-FENSTER®

Schwellen

Lüftungssystem

Hebeschiebesysteme

Schiebesysteme

Rollladen

Klappladen

Scuro

Cassonetto

Sonstiges

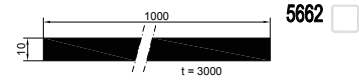
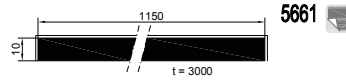
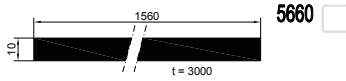
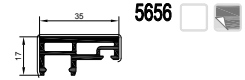
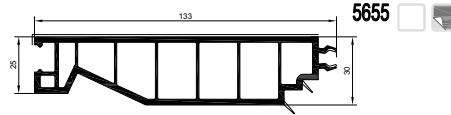
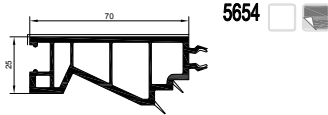

Sonstiges · Miscellaneous

Sonstiges

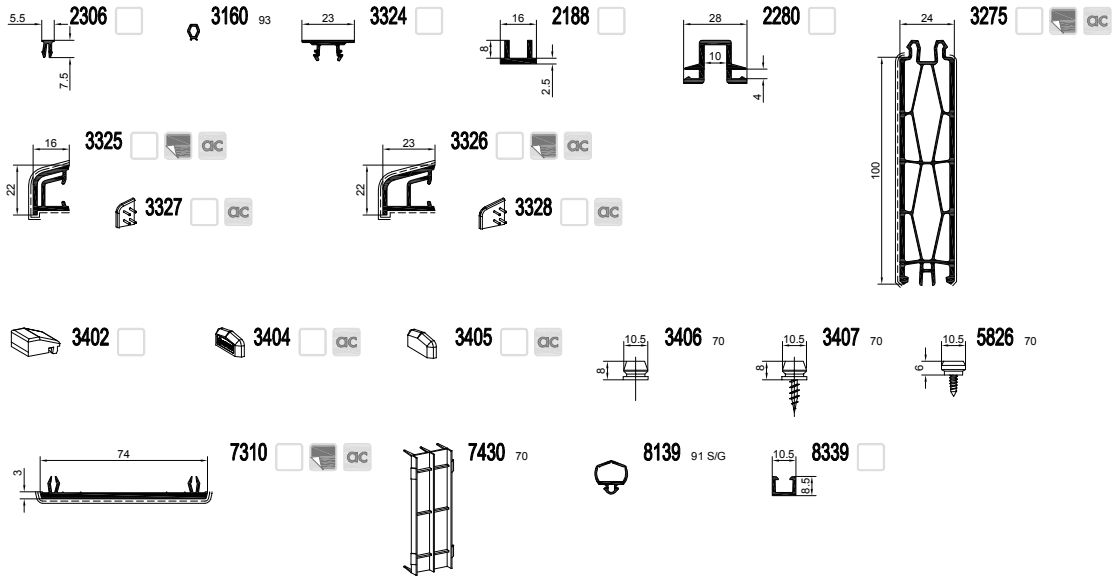

- S 7000 IQ
- S 7000 IQ plus
- S 8000 IQ
- S 9000
- S 9000 plus
- GEALAN-KUBUS*
- S 9000 NL
- Stulp
- Sprossen
- Glasleisten
- Aussteifungen
- Dichtungen
- Rahmenverbreiterungen
- Kopplungsprofile
- Eckprofile
- Verleistungen
- Untere Anschlussprofile
- Laibungsverkleidungen
- GEALAN HAFEN-CITY-FENSTER®
- Schwellen
- Lüftungssystem
- Hebeschiebesysteme
- Schiebesysteme
- Rollladen
- Klappladen
- Scuro
- Cassonetto

Falztiefe 40 mm



Falztiefe 55 mm



Falztiefe 61 mm



Falztiefe 67,5 mm

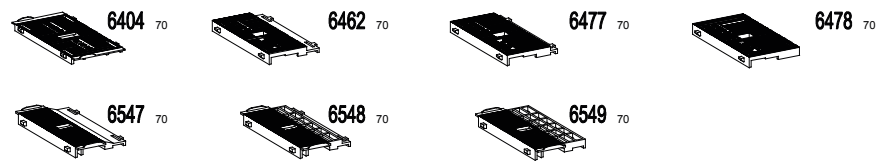

Falztiefe 69 mm

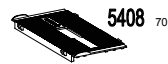

Maueranker



Sonstiges

Art.-Nr.:		Seite
2101	Unterer Anschluss	36
2143	Dichtung	30
2144	Dichtung	30
2147	Dichtung	31
2149	Dichtung	30
2155	Dichtung	31
2156	Dichtung	30
2157	Dichtung	30
2160	Klebeband	31
2163	Klebeband	31
2165	Dichtung	30
2167	Dichtung	30
2172	Dichtung	31, 34
2188	Kammerbrücke	55
2203	Außenfensterbank	36
2207	Aufnahmeprofil	35, 50
2209	Außenfensterbank	36
2211	Unterer Anschluss	36
2212	Unterer Anschluss	36
2213	Außenfensterbank	36
2219	Außenfensterbank	36
2220	Verblendeiste	35
2221	Außenfensterbank	36
2224	Führungsschiene	49
2225	Adapterprofil	49
2226	Verblendeiste	35
2230	Unterer Anschluss	36
2233	Rundprofil	34
2234	Rundrohradapter	34
2237	Abdeckwinkel	35, 36
2238	Winkelprofil	35
2239	Abdeckwinkel	36
2241	Verblendeiste	35
2243	Verblendeiste	35
2247	Verblendeiste	35
2249	Lisenenprofil	33
2251	Winkelprofil	35
2253	Winkelprofil	35
2254	Verblendeiste	35
2255	Knickleiste	35
2257	Verblendeiste	35
2263	Verblendeiste	35
2265	Verblendeiste	35
2266	Laibungsverkleidung	38
2267	Unterer Anschluss	37
2268	Laibungsverkleidung	38

Art.-Nr.:		Seite
2269	Laibungsverkleidung	38
2270	Laibungsverkleidung	38
2271	Laibungsverkleidung	38
2272	Verblendeiste	35
2273	Verblendeiste	35
2275	Führungsschiene	49
2276	Führungsschiene	49
2280	Kopplungsprofil	55
2282	Kopplungsprofil	33
2298	Verblendeiste	35
2304	Eckprofil	34
2306	Nutenfüller	55
2311	Blendrahmenverbreiterung	32
2312	Ausgleichsprofil	35, 49
2313	Blendrahmenverbreiterung	32
2315	Blendrahmenverbreiterung	32
2316	Verblendeiste	35
2325	Verblendeiste	34, 35
2326	Lisenenprofil	33
2327	Kopplungsprofil	33
2328	Abdeckprofil	33
2347	Einschubleiste	50
2409	Verbindungsschiene	35
2411	Verbinder	35
2413	Montagehilfe	33
2415	Verbindungsschiene	35
2421	Einlauftrichter	49
2423	Einlauftrichter	49
2424	Einlauftrichter	49
2442	Zarge	39
2443	Zargendeckel	39
2444	Dichtung	39
2445	Aluwinkel	39
2446	Aluwinkel	39
2447	Zargendeckel	39
2503	Abrolltraverse	49
2576	Abdeckprofil	40, 41, 42
2580	Bürstendichtung	31, 40, 41
2587	Bürstendichtung	31, 40, 41
2590	Bürstendichtung	40
2591	Endkappe	40
2592	Stulpkappe	40
2593	Stulpkappe	40
2595	Schwelle	40
2596	Schwelle	41, 42
2597	Aluleiste	40

Art.-Nr.:		Seite
2703	Aussteifung	27
2724	Aussteifung	19, 22, 27, 47
2756	Aussteifung	27
2770	Aussteifung	27
3029	Blendrahmen	47
3083	Flügel	47
3110	Glasleiste	26
3111	Glasleiste	26
3122	Dichtung	30
3123	Dichtung	30
3151	Dichtung	19, 22, 31
3152	Dichtung	30, 47
3153	Dichtung	30
3156	Dichtung	31, 33
3158	Bürstendichtung	10, 31, 40
3160	Dichtung	31, 55
3162	Dichtung	31
3165	Dichtung	31, 33
3167	Dichtung	30
3169	Dichtung	31, 33
3170	Dichtung	31, 33
3171	Dichtung	21, 23, 31
3172	Dichtung	31
3173	Dichtung	30, 31
3177	Dichtung	25, 31, 44
3178	Dichtung	31, 32
3179	Dichtung	31, 33
3182	Glasfalzverbreiterung	26
3184	Dichtung	30, 31, 48
3185	Dichtung	30
3195	Sprosse	25
3196	Sprosse	25
3197	Sprosse	25
3198	Sprosse	25
3205	Unterer Anschluss	36
3206	Unterer Anschluss	36
3207	Außenfensterbank	36
3208	Unterer Anschluss	36
3210	Außenfensterbank	36
3215	Unterer Anschluss	36
3216	Unterer Anschluss	36
3217	Unterer Anschluss	36
3218	Verblendleiste	35
3229	Außenfensterbank	36
3230	Außenfensterbank	36
3232	Außenfensterbank	36

Art.-Nr.:		Seite
3239	Abdeckwinkel	36
3240	Lisenenprofil	33
3244	Verblendleiste	35
3245	Verblendleiste	35
3250	Winkelprofil	35
3251	Winkelprofil	35
3252	Winkelprofil	35
3253	Winkelprofil	35
3254	Winkelprofil	35
3258	Verblendleiste	35
3260	Verblendleiste	35
3261	Verblendleiste	35
3262	Verblendleiste	35
3263	Verblendleiste	35
3264	Verblendleiste	35
3265	Verblendleiste	35
3268	Laibungsverkleidung	38
3269	Laibungsverkleidung	38
3270	Laibungsverkleidung	38
3271	Laibungsverkleidung	38
3275	Füllprofil	51, 55
3279	Adapterprofil	44
3284	Kopplungsprofil	33
3292	Abdeckprofil	33
3308	Deckleiste	20, 21
3313	Stulpschlagleiste	21
3314	Stulpschlagleiste	21
3324	Kammerbrücke	55
3325	Wetterschenkel	55
3326	Wetterschenkel	55
3327	Endkappe	55
3328	Endkappe	55
3340	Abrolltraverse	50
3342	Abrolltraverse	50
3345	Einschubleiste	50
3346	Einschubleiste	50
3347	Führungsschiene	49
3348	Führungsschiene	49
3349	Führungsschiene	49
3350	Führungsschiene	49
3351	Führungsschiene	49
3352	Bürstendichtung	31, 44, 49
3354	Bürstendichtung	31, 49
3355	Führungsschiene	49
3356	Ausgleichsprofil	49
3357	Ausgleichsprofil	49

Art.-Nr.:		Seite
3362	Unterer Anschluss	36
3369	Abdeckprofil	47
3370	Dichtleiste	47
3371	Bürstendichtung	31 47
3400	GEALAN Airwatch	43
3401	GECCO 3	43
3402	Auflaufbock	55
3403	Dichtblock	47
3404	Wasserschlitzkappen	55
3405	Wasserschlitzkappen	55
3406	Klemmnippel	49, 55
3407	Klemmnippel	55
3416	Stulpkappe	21
3418	Stulpkappe	21
3421	Endkappe	21
3429	Einlauftrichter	49
3434	Einlauftrichter	49
3436	Einlauftrichter	49
3438	Einlauftrichter	49
3439	Endkappe	49
3440	Endkappe	49
3451	Trittschutzschiene	40
3458	Trittschutzschiene	40
3461	Koppelschraube	33
3476	Schraubenset	4
3482	Koppelschraube	33
3483	Hülsenmutter	33
3532	Trittschutzschiene	40
3559	Montagehilfe	33
3561	Glasfalzanschlagprofil	33
3562	Glasfalzanschlagprofil	33
3563	Glasfalzeinlage	33
3587	Endkappe	36
3588	Endkappe	36
3660	GECCO 4	43
3662	GECCO 4	43
3702	Aussteifung	27
3710	Aussteifung	27
3712	Aussteifung	27
3754	Aussteifung	27
3760	Alu-Laufschiene	47
3762	Aussteifung	27, 47
3763	Aussteifung	27, 47
3798	Aussteifung	27
3802	Blende	35
3815	Führungsschiene	49

Art.-Nr.:		Seite
4794	Aussteifung	27
5002	Blendrahmen	3
5006	Pfosten	4
5007	Flügel	5
5010	Blendrahmen	3
5011	Flügel	5
5012	Flügel	5
5013	Pfosten	4
5015	Sprosse	25
5019	Monostulp	21
5060	Blendrahmen	16
5061	Flügel	16
5062	Monostulp	16, 24
5063	Pfosten	16
5065	Blendrahmen	16
5101	Dichtplatte	31, 32
5102	Dichtplatte	25
5163	Dichtung	30
5164	Dichtung	16, 30
5166	Dichtung	16, 30
5201	Blendrahmenverbreiterung	32
5202	Blendrahmenverbreiterung	32
5203	Blendrahmenverbreiterung	32
5204	Kopplungsprofil	33
5206	Rundprofil	34
5207	Rundrohradapter	34
5209	Stulpprofil	21
5210	Abrolltraverse	50
5211	Glasfalzverbreiterung	26
5212	Glasfalzverbreiterung	26
5213	Blendrahmenverbreiterung	32
5214	Stulpprofil	21
5260	Stulpschlagleiste	16, 24
5261	Verblendleiste	16, 35
5403	Alu-Vorsatzschale	5
5404	Alu-Vorsatzschale	4
5406	Trittschutzschiene	41
5408	Glasfalzeinlage	55
5410	Stulpkappe	21
5413	Alu-Vorsatzschale	21
5415	Set-Schwellenverbinder	41
5417	Stulpkappe	21
5418	Abdeckkappe	21
5419	Alu-Vorsatzschale	4
5461	Stulpkappe	24
5462	Verbinder	16

Art.-Nr.:		Seite
5463	Wetterschenkel	42
5464	Endkappe	42
5465	Stulpkappe	42
5466	Schwellenverbinder	42
5468	Verbinder	16
5469	Auflaufbock	16
5470	Montagehilfe	16
5471	Stulpkappe	24
5473	Auflaufbock	16
5474	Glasfalzeinlage	16, 55
5477	Dichtblock	42
5478	Dichtplatte	16
5479	Dichtblock	42
5480	Abdeckkappe	16
5481	Federblech	16
5483	Montagehilfe	16
5484	Unterlegplatte	16
5486	Pfostenverbinder	16
5487	Schraubenset	16
5488	Verbindungslasche	16
5489	Schwellenverbinder	42
5491	Verbinder	16
5500	Monoblock	6
5501	Monoblock	6
5502	Monoblock	7
5503	Monoblock	7
5504	Blendrahmen	8
5505	Blendrahmen	7
5507	Blendrahmen	8
5510	Flügel	11
5511	Monostulp	22
5512	Flügel	11
5513	Monostulp	22
5515	Blendrahmen	8
5516	Blendrahmen	8
5517	Monoblock	7
5518	Ausgleichsprofil	8
5520	Ausgleichsprofil	7, 8, 13
5521	Ausgleichsprofil	7, 8, 13
5522	Stulpprofil	21
5523	Stulpschlagleiste	21
5524	Glasleiste	26
5525	Glasleiste	26
5526	Glasleiste	26
5527	Stulpschlagleiste	21
5531	Blendrahmen	8

Art.-Nr.:		Seite
5532	Stulpschlagleiste	21
5534	Ausgleichsprofil	7
5560	Stulpkappe	21
5561	Stulpkappe	21
5563	Endkappe	6, 7
5564	Abdeckkappe	7, 8, 13
5565	Abdeckkappe	8
5566	Stulpkappe	21
5567	Stulpkappe	21
5568	Abdeckkappe	7
5654	Basisprofil	54
5655	Basisprofil	54
5656	Ecken- und Rahmenprofil	54
5660	Füllprofil	54
5661	Füllprofil	54
5662	Füllprofil	54
5663	Zarge	53
5664	Zarge	53
5665	Füllprofil	53
5666	Füllprofil	53
5667	Stulpprofil	53
5668	Deckleiste	53
5669	Aussteifung	27, 53
5670	Aussteifung	27, 53
5671	Endkappe	53
5672	Endkappe	53
5673	Endkappe	53
5674	Klemmnippel	51, 53
5675	Zarge	53
5676	Laibungsverkleidung	53
5700	Aussteifung	27
5760	Aussteifung	27
5762	Aussteifung	27
5763	Aussteifung	27
5764	Aussteifung	27
5765	Aussteifung	27
5766	Aussteifung	27
5767	Aussteifung	27
5802	Blendrahmen	47
5803	Flügel	47
5805	Flügel	47
5806	Labyrinthprofil	47
5807	Sprosse	47
5822	Führungsschiene	50
5823	Führungsschiene	50
5824	Führungsschiene	50

Art.-Nr.:		Seite
5825	Führungsschiene	50
5826	Klemmnippel	50, 55
5832	Aussteifung	27, 47, 48
5833	Aussteifung	27, 47
5834	Aussteifung	27, 47
5836	Aussteifung	27, 47
5837	Alu-Laufschiene	47
5838	Glasfalzeinlage	47, 55
5839	Dichtblock	47
5840	Adapter	47
5841	Stulpprofil	47
5843	Abdeckkappe	47
5848	Aussteifung	27, 47
5849	Dichtplatte	47
5854	Aussteifung	27, 47
5860	Blendrahmen	48
5861	Abdeckprofil	48
5862	Flügel	48
5863	Festverglasungsprofil	48
5868	Labyrinthprofil	48
5869	Zargenaufbauprofil	48
5880	Aussteifung	27, 48
5882	Alu-Führungsschiene	48
5883	Aluleiste	48
5884	Alu-Führungsschiene	48
5885	Trittschutzschiene	48
5886	Aufnahmeprofil	48
5888	Aluleiste	48
5889	Bürstendichtung	33, 48
5890	Endkappe	48
5891	Falzeckwinkel	48
5892	Dichtplatte	48
5928	Blockzarge	51
5929	Blockzarge	51
5930	Blendrahmen-Aufsatz	51
5931	Blendrahmen	51
5932	Blendrahmen	51
5933	Klappladensprosse	51
5934	Klappladenzarge	51
5935	Blockzarge	51
5940	Klappladenlamelle	51
5941	Klappladenlamelle	51
5942	Klappladenlamelle-Endstab	51
5943	Distanzplatte	51
5950	Lamellenhalteleiste	51
5952	Lamellenhalteleiste	51

Art.-Nr.:		Seite
5953	Glasleiste	51
5954	Glasleiste	51
5955	Anschlagleiste	51
5958	Stulpprofil	51
5960	Aussteifung	27, 52
5961	Aussteifung	27, 52
5962	Aussteifung	27, 52
5964	Aussteifung	27, 52
5965	Alu-Aussteifung	27, 52
5966	Alu-Aussteifung	27, 52
5967	Alu-Aussteifung	27, 52
5969	Aluschiene	52
5970	Dichtung	52
5971	Dichtung	52
5972v	Dichtung	51
5974	Drehknopf	52
5975	Stulpkappe	51
5978	Aluleiste	51
5982	Stulpkappe	51
6001	Blendrahmen	12
6002	Blendrahmen	12
6003	Flügel	14
6009	Blendrahmen	13
6012	Stulpprofil	23
6015	Blendrahmen	12
6016	Blendrahmen	12
6017	Flügel	14
6020	Stulpprofil	23
6023	Flügel	14
6025	Flügel	15
6027	Flügel	15
6029	Monostulp	24
6031	Blendrahmen	12
6032	Blendrahmen	12
6033	Flügel	15
6034	Blendrahmen-Aufsatz	15
6035	Blendrahmen	12
6036	Blendrahmen	12
6039	Flügel	15
6042	Stulpprofil	23
6045	Blendrahmen	12
6047	Blendrahmen	12
6048	Blendrahmen	12
6049	Pfosten	13
6050	Pfosten	13
6053	Pfosten	13

Art.-Nr.:		Seite
6054	Pfosten	13
6055	Flügel	14
6057	Pfosten	14
6058	Pfosten	14
6059	Stulpprofil	24
6061	Flügel	15
6063	Wechselfosten	19
6064	Wechselfosten	19
6065	Flügel	15
6066	Blendrahmen	12
6067	Flügel	15
6069	Blendrahmen	19
6070	Blendrahmen	19
6071	Blendrahmen	19
6072	Blendrahmen	19
6077	Blendrahmen	12
6079	Flügel	14
6081	Pfosten	13
6101	Dichtung	30
6104	Dichtung	30, 45
6105	Bürstendichtung	31, 42
6106	Dichtung	30, 45
6111	Dichtplatte	41
6113	Dichtplatte	41
6114	Dichtplatte	41
6115	Dichtung	19, 31
6124	Glasleiste	26
6126	Glasleiste	26
6128	Glasleiste	26
6130	Glasleiste	26
6132	Glasleiste	26
6134	Glasleiste	26
6136	Glasleiste	26
6138	Glasleiste	26
6140	Glasleiste	26
6142	Glasleiste	26
6144	Glasleiste	26
6146	Glasleiste	26
6148	Glasleiste	26
6150	Glasleiste	26
6151	Dichtung	30
6152	Glasleiste	26
6211	Abrolltraverse	50
6212	Dämmprofil	19
6277	Balkonanschlussprofil	37
6281	Kopplungsprofil	33

Art.-Nr.:		Seite
6288	Balkonanschlussprofil	37
6299	Balkonanschlussprofil	37
6301	Stulpschlagleiste	23
6326	Bürstendichtung	31, 45
6327	Bürstendichtung	31, 45
6328	Aluleiste	45
6329	Aluleiste	45
6330	Dichtblock	46
6331	Dichtblock	46
6337	Alu-Vorsatzschale	45
6338	Dichtblock	46
6339	Aussteifung	27, 45
6340	Aussteifung	27, 45
6341	Alu-Vorsatzschale	45
6342	Alu-Vorsatzschale	45
6343	Alu-Vorsatzschale	45
6345	Dichtblock	46
6347	Dichtblock	46
6348	Führungsgleiter	46
6349	Dichtblock	46
6350	Alu-Vorsatzschale	45
6351	Alu-Vorsatzschale	45
6354	Alu-Vorsatzschale	45
6355	Alu-Vorsatzschale	45
6358	Abdeckkappe	46
6359	Aluleiste	45
6360	Blendrahmen	45
6361	PVC-Profil	45
6362	Flügel	45
6363	Blendrahmen	45
6365	PVC-Profil	45
6366	PVC-Profil	45
6367	PVC-Profil	45
6368	Labyrinthprofil	45
6369	PVC-Profil	45
6370	Dichtung	31, 45
6373	Bürstendichtung	31, 45
6374	Bürstendichtung	31, 45
6375	Dichtplatte	45
6376	Dichtplatte	45
6377	Dichtblock	46
6378	Führungsgleiter	45
6380	Alu-Aussteifung	27, 45
6381	Aussteifung	27, 45
6382	Alu-Aussteifung	27, 45
6383	Aussteifung	27, 45

Art.-Nr.:		Seite
6384	Aluschiene	45
6386	Aussteifung	27, 45
6387	Aluleiste	45
6388	Aussteifung	27, 45
6390	Alu-Schwellenabdeckung	46
6391	Dichtplatte	46
6395	Dichtplatte	45
6396	Verbinder	45
6397	Dichtung	45
6398	Dehnungsausgleichsblock	46
6399	Dehnungsausgleichsblock	46
6403	Stulpkappe	23
6404	Glasfalzeinlage	55
6407	Schweißbeckverbinder	14, 15
6409	Schweißbeckverbinder	15
6410	Pfostenverbinder	13
6414	Schraubenset	13
6418	Pfostenverbinder	13
6419	Schraubenset	13
6421	Füllprofil	15
6422	Falzeckwinkel	13, 45
6423	Stulpkappe	23
6424	Abdeckkappe	24
6425	Stulpkappe	23
6426	Stulpkappe	23
6427	Stulpkappe	23
6428	Stulpkappe	23
6429	Set-Schwellenverbinder	41
6430	Schwellenverbinder	41
6431	Wetterschenkel	42
6432	Stulpkappe	42
6433	Endkappe	42
6434	Schwellenverbinder	41
6435	Stulpkappe	42
6436	Aluleiste	42
6437	Schwellenverbinder	41
6438	Pfostenverbinder	13
6440	Stulpkappe	23
6441	Pfostenverbinder	13
6442	Pfostenverbinder	13
6443	Pfostenverbinder	13
6444	Pfostenverbinder	13
6445	Schrägpfostenverbinder	13
6446	Kreuzverbinder	13
6447	Stulpkappe	42
6449	Stulpkappe	42

Art.-Nr.:		Seite
6450	Stulpstopfen	42
6454	Koppelschraube	33
6455	Koppelschraube	33
6456	Koppelschraube	33
6457	Dichtblock	41
6460	Dichtplatte	13
6461	Dichtplatte	13
6462	Glasfalzeinlage	55
6463	Wetterschenkel	42
6463	Wetterschenkel	42
6464	Stulpkappe	42
6465	Pfostenverbinder	13
6466	Kreuzverbinder	13
6469	Stulpkappe	42
6470	Bürstendichtung	31, 42
6471	Stulpkappe	23
6472	Stulpkappe	23
6473	Glasfalzanschlagprofil	33
6474	Glasfalzanschlagprofil	33
6475	Schwellenverbinder	41
6477	Glasfalzeinlage	55
6478	Glasfalzeinlage	55
6479	Pfostenverbinder	17, 18
6480	Adapter	17, 18
6481	Pfostenverbinder	17, 18
6482	Adapter	17, 18
6483	Schrägpfostenverbinder	13
6486	Stulpkappe	23
6487	Stulpkappe	23
6488	Dichtblock	41
6489	Füllprofil	41
6491	Stulpkappe	42
6492	Pfostenverbinder	17, 18
6493	Stulpkappe	23
6494	Stulpkappe	23
6497	Dichtplatte	17, 18
6500	Pfostenverbinder	14
6501	Pfostenverbinder	14
6502	Pfostenverbinder	14
6503	Pfostenverbinder	14
6504	Falzeckwinkel	13, 14
6507	Schwellenverbinder	41
6508	Schwellenverbinder	41
6509	Dichtblock	41
6529	Füllprofil	17, 18
6547	Glasfalzeinlage	55

Art.-Nr.:		Seite
6548	Glasfalzeinlage	55
6549	Glasfalzeinlage	55
6617	Alu-Vorsatzschale	12
6618	Alu-Vorsatzschale	12, 13
6619	Alu-Vorsatzschale	14
6620	Alu-Vorsatzschale	14
6621	Alu-Vorsatzschale	15
6622	Alu-Vorsatzschale	13, 14
6623	Alu-Vorsatzschale	13
6624	Alu-Vorsatzschale	23
6625	Alu-Vorsatzschale	23
6626	Alu-Vorsatzschale	23
6627	Alu-Vorsatzschale	12
6628	Alu-Vorsatzschale	23
6629	Alu-Vorsatzschale	23
6630	Alu-Vorsatzschale	13, 14
6631	Alu-Vorsatzschale	13
6632	Alu-Vorsatzschale	15
6633	Alu-Vorsatzschale	12
6636	Alu-Vorsatzschale	12
6637	Alu-Vorsatzschale	15
6638	Alu-Vorsatzschale	15
6639	Alu-Vorsatzschale	14
6705	Aussteifung	27
6706	Aussteifung	27
6708	Aussteifung	27
6709	Aussteifung	27
6711	Aussteifung	27
6712	Aussteifung	27
6713	Aussteifung	27
6714	Aussteifung	27
6715	Aussteifung	27
6716	Aussteifung	27
6717	Aussteifung	27
6718	Aussteifung	27, 48
6720	Aussteifung	28
6721	Aussteifung	28
6722	Aussteifung mit Schlossfräsung	28
6726	Aussteifung	28
6727	Aussteifung	28
6728	Aussteifung	28
6729	Aussteifung	28
6730	Aussteifung	28
6733	Aussteifung	28
6736	Aussteifung	28
6737	Aussteifung	28

Art.-Nr.:		Seite
6738	Aussteifung	28
6742	Aussteifung	28
6743	Aussteifung	28
6744	Aussteifung	28
6745	Aussteifung	28
6746	Aussteifung	28
6747	Aussteifung	28
6748	Aussteifung	28
6750	Aussteifung	28
6751	Aussteifung	28
6752	Aussteifung	28
6753	Aussteifung	28
6754	Aussteifung	28
6755	Aussteifung	19, 28
6757	Aussteifung	28
6758	Aussteifung	19, 28
6760	Aussteifung	19, 28
6763	Aussteifung	28
6764	Aussteifung	19, 28
6765	Aussteifung	19, 28
6766	Alu-Aussteifung	19, 28
6767	Aussteifung	19, 28
6768	Aussteifung	19, 28
6769	Aussteifung	19, 28
6770	Aussteifung	19, 28
6771	Aussteifung	19, 28
6772	Aussteifung	28
6773	Aussteifung	28
6774	Aussteifung	28
6775	Aussteifung	28
6791	Aussteifung	28, 42
6801	Blendrahmen	17
6802	Blendrahmen	17
6803	Blendrahmen	18
6804	Blendrahmen	18
6805	Blendrahmen	17
6806	Blendrahmen	17
6807	Blendrahmen	17, 18
6808	Blendrahmen	17, 18
6809	Wechselpfosten	17
6810	Wechselpfosten	17
6811	Wechselpfosten	18
6812	Wechselpfosten	18
6813	Blendrahmen	18
6814	Blendrahmen	18
6815	Pfosten	17

Art.-Nr.:		Seite
6816	Pfosten	17
6817	Pfosten	18
6818	Pfosten	18
6819	Blendrahmen	17, 18
6820	Blendrahmen	17, 18
6821	Blendrahmen	17
6841	Adapterprofil	17
6842	Adapterprofil	17
6843	Adapterprofil	19
6844	Adapterprofil	18
6845	Adapterprofil	19
6846	Adapterprofil	19
7008	Blendrahmen	3
7011	Blendrahmen	3
7014	Blendrahmen	3
7026	Blendrahmen	3
7030	Blendrahmen	3
7035	Sprosse	25
7036	Sprosse	25
7037	Pfosten	4, 20
7043	Pfosten	4
7066	Flügel	5
7069	Monostulp	20
7080	Stulpprofil	20
7081	Flügel	5
7093	Flügel	5
7116	Glasleiste	26
7118	Glasleiste	26
7119	Glasleiste	26
7120	Glasleiste	26
7122	Glasleiste	26
7128	Glasleiste	26
7129	Glasleiste	26
7130	Glasleiste	26
7131	Glasleiste	26
7134	Glasleiste	26
7138	Glasleiste	26
7139	Glasleiste	26
7142	Glasleiste	26
7144	Glasleiste	26
7146	Glasleiste	26
7149	Dichtung	30
7151	Dichtung	30
7154	Glasleiste	26
7156	Glasleiste	26
7157	Dichtung	30

Art.-Nr.:		Seite
7158	Dichtung	30
7159	Dichtung	30, 40, 41
7160	Dichtplatte	31, 32
7161	Dichtung	4, 31
7162	Glasleiste	26
7164	Glasleiste	26
7180	Glasleiste	26
7181	Glasfalzverbreiterung	26
7194	Glasleiste	26
7196	Glasleiste	26
7201	Unterer Anschluss	37
7202	Unterer Anschluss	37
7205	Unterer Anschluss	37
7206	Unterer Anschluss	37
7208	Unterer Anschluss	37
7209	Unterer Anschluss	37
7213	Außenfensterbank	36
7281	Kopplungsprofil	33
7288	Balkonanschlussprofil	37
7289	Blendrahmenverbreiterung	32
7290	Blendrahmenverbreiterung	32
7291	Kopplungsprofil	33
7292	Blendrahmenverbreiterung	32
7298	Blendrahmenverbreiterung	32
7299	Balkonanschlussprofil	37
7300	Stulpprofil	20
7302	Stulpprofil	20
7303	Stulpprofil	20
7309	Stulpschlagleiste	20
7310	Blendrahmen-Abdeckung	55
7340	Abrolltraverse	50
7341	Abrolltraverse	50
7342	Abrolltraverse	50
7401	GECCO 2	43
7407	Glasfalzeinlage	55
7408	Glasfalzeinlage	55
7410	Glasfalzeinlage	55
7411	Schrägpfostenverbinder	4
7413	Schrägpfostenverbinder	25
7414	Stulpkappe	20
7416	Stulpkappe	20
7418	Stulpkappe	20
7419	Gegenstück	20
7422	Stulpkappe	20
7423	Stulpkappe	20, 21
7424	Stulpkappe	20, 21

Art.-Nr.:		Seite
7425	Stulpkappe	20
7430	Montagefalzklotz	55
7431	Kopplungsfalzklotz	33
7434	Stulpkappe	20
7435	Stulpkappe	20
7459	Trittschutzschiene	40, 42
7460	Aluleiste	40, 41
7473	Falzeckwinkel	9, 25
7476	Schraubenset	9, 25
7478	Schraubenset	25
7479	Schraubenset	4
7481	Schwelle	40
7482	Koppelschraube	33
7486	Sprossenverbinder	25
7490	Pfostenverbinder	4
7491	Kreuzverbinder	4
7492	Pfostenverbinder	4
7493	Pfostenverbinder	4
7497	Pfostenverbinder	9, 25
7498	Maueranker	55
7499	Maueranker	55
7500	Verbinder	35
7503	Alu-Vorsatzschale	3
7504	Alu-Vorsatzschale	3
7505	Alu-Vorsatzschale	3
7507	Alu-Vorsatzschale	5
7508	Alu-Vorsatzschale	5
7509	Alu-Vorsatzschale	4
7510	Alu-Vorsatzschale	4, 20
7511	Alu-Vorsatzschale	20
7512	Stulpkappe	20, 21
7513	Alu-Vorsatzschale	20
7514	Alu-Vorsatzschale	5
7523	Schwellenverbinder	40
7525	Set-Schwellenverbinder	40
7701	Aussteifung	28
7702	Aussteifung	28
7703	Aussteifung	28
7704	Aussteifung	28
7705	Aussteifung	28
7706	Aussteifung	28
7707	Aussteifung	28
7708	Aussteifung	28
7709	Aussteifung	28
7710	Aussteifung	28
7711	Aussteifung	29

Art.-Nr.:		Seite
7713	Aussteifung	29
7715	Aussteifung	29
7717	Aussteifung	29
7718	Aussteifung	29
7719	Aussteifung	29
7722	Aussteifung	29
7724	Aussteifung	29
7726	Aussteifung	29
7734	Aussteifung	29
7796	Aussteifung	29
8001	Blendrahmen	6
8006	Blendrahmen	6
8010	Blendrahmen	6
8012	Blendrahmen	6
8013	Blendrahmen	6
8014	Blendrahmen	6
8015	Blendrahmen	6
8032	Blendrahmen	6
8033	Blendrahmen	7
8034	Blendrahmen	7
8036	Pfosten	9, 25
8037	Pfosten	9
8038	Pfosten	9
8039	Pfosten	9
8040	Pfosten	9
8042	Flügel	11
8043	Pfosten	9
8063	Flügel	10
8068	Flügel	10
8069	Monostulp	22
8071	Monostulp	22
8072	Flügel	10
8073	Monostulp	22
8074	Monostulp	22
8076	Flügel	10
8077	Flügel	11
8078	Flügel	11
8079	Flügel	10
8080	Flügel	11, 22
8081	Flügel	10
8088	Flügel	11
8092	Flügel	10
8095	Flügel	11
8096	Flügel	11
8097	Flügel	10
8098	Monostulp	22

Art.-Nr.:		Seite
8139	Dichtung	31, 55
8150	Dichtung	30
8156	Dichtung	30
8176	Dichtung	31, 40, 42
8177	Dichtung	10, 11, 31
8178	Dichtung	31, 40, 41, 42
8186	Dichtung	30
8187	Dichtung	30
8273	Blendrahmen-Aufsatz	10, 11, 40
8300	Stulpprofil	21
8302	Stulpprofil	21
8304	Stulpprofil	22
8309	Stulpschlagleiste	21, 23
8339	Aufnahmepprofil	55
8345	Dichtblock	44
8350	Dichtplatte	44
8351	Dichtblock	44
8360	Blendrahmen	44
8361	Abdeckprofil	44
8362	Flügel	44
8365	Anschlagleiste	44
8366	Führungsleiste	44
8367	Dichtleiste	44
8368	Labyrinthprofil	44
8370	Dichtung	31, 44
8371	Dichtung	31, 44
8372	Dichtung	31, 44
8373	Dichtung	31, 44
8374	Dichtung	31, 44
8375	Zargendichtungsplatte	44
8376	Dichtung	44
8377	Dichtung	44
8378	Dichtung	44
8381	Alu-Vorsatzschale	44
8382	Alu-Vorsatzschale	44
8383	Alu-Vorsatzschale	44
8385	Alu-Vorsatzschale	44
8386	Alu-Vorsatzschale	44
8387	Alu-Vorsatzschale	44
8388	Alu-Vorsatzschale	44
8389	Alu-Vorsatzschale	44
8390	Alu-Aussteifung	29, 44
8391	Aussteifung	29, 44
8392	Aussteifung	29, 44
8393	Aussteifung	29, 44
8394	Alu-Vorsatzschale	44

Art.-Nr.:		Seite
8395	Aluleiste	44
8396	Aluleiste	44
8397	Alu-Schwellenabdeckung	44
8398	Alu-Laufschiene	44, 46
8401	Clipsverbinder	22
8411	Schrägpfostenverbinder	9
8412	Schrägpfostenverbinder	9
8415	Abdeckkappe	20, 22
8441	Schweißbeckverbinder	10, 11, 15
8443	Schweißbeckverbinder	10, 11, 15
8459	Trittschutzschiene	40
8471	Schwelle	40
8477	Schraubenset	9
8478	Schraubenset	9
8479	Schraubenset	9
8490	Pfostenverbinder	9
8491	Kreuzverbinder	9
8492	Pfostenverbinder	9
8493	Kreuzverbinder	9
8494	Pfostenverbinder	9
8495	Kreuzverbinder	9
8496	Pfostenverbinder	9
8497	Kreuzverbinder	9
8498	Pfostenverbinder	9
8499	Pfostenverbinder	9
8500	Kreuzverbinder	9
8505	Pfostenverbinder	9
8510	Stulpkappe	22
8511	Stulpkappe	22
8512	Stulpkappe	22
8513	Stulpkappe	21
8514	Stulpkappe	21
8515	Stulpkappe	21
8516	Stulpkappe	22
8521	Schwellenverbinder	40
8522	Schwellenverbinder	40
8523	Schwellenverbinder	40
8527	Schwellenverbinder	40
8528	Schwellenverbinder	40
8538	Set-Schwellenverbinder	40
8539	Schwellenverbinder	40
8540	Schwellenverbinder	40
8541	Schwellenverbinder	40
8543	Set-Schwellenverbinder	40
8551	Dichtblock	40
8558	Montagehilfe	34

Art.-Nr.:		Seite
8560	Schwelle	41
8561	Schwelle	41
8562	Schwelle	41
8563	Schwellenverbinder	41
8564	Schwellenverbinder	41
8565	Schwellenverbinder	41
8566	Schwellenverbinder	41
8567	Schwellenverbinder	41
8568	Schwellenadapter	41
8569	Schwellenverbreiterung	41
8570	Schwellenverbreiterung	41
8576	Wetterschenkel	41
8577	Abdeckkappe	41
8578	Bürstendichtung	41
8579	Schwellenverbinder	41
8581	Schwellenverbinder	41
8582	Schwellenverbinder	41
8583	Schwellenverbinder	41
8584	Stahlplatte	41
8585	Stahlplatte	41
8586	Stahlplatte	41
8590	Dichtblock	41
8591	Dichtblock	41
8601	Alu-Vorsatzschale	6, 7
8602	Alu-Vorsatzschale	6
8605	Alu-Vorsatzschale	6
8607	Alu-Vorsatzschale	9, 25
8608	Alu-Vorsatzschale	9, 25
8609	Alu-Vorsatzschale	9
8611	Alu-Vorsatzschale	11
8612	Alu-Vorsatzschale	21
8613	Alu-Vorsatzschale	10
8614	Alu-Vorsatzschale	10, 11
8615	Alu-Vorsatzschale	10
8616	Alu-Vorsatzschale	10
8617	Alu-Vorsatzschale	22
8618	Alu-Vorsatzschale	22
8619	Dichtung	30, 44
8621	Stulpkappe	22
8622	Stulpkappe	21
8666	Aussteifung	29, 53
8701	Aussteifung	29
8702	Aussteifung	29
8703	Aussteifung	29
8704	Aussteifung	29
8705	Aussteifung	29

Art.-Nr.:		Seite
8706	Aussteifung	29
8707	Aussteifung	29
8708	Aussteifung	29
8709	Aussteifung	29
8710	Aussteifung	29
8713	Aussteifung	29
8714	Aussteifung	29
8715	Aussteifung	29
8716	Aussteifung	29
8719	Aussteifung	29
8723	Aussteifung	29
8724	Aussteifung	29
8727	Aussteifung	29
8732	Alu-Aussteifung	29
8733	Alu-Aussteifung	29
8736	Aussteifung	29
8737	Aussteifung	29
8751	Aussteifung	29
8753	Aussteifung	29
8754	Aussteifung	29
8758	Aussteifung	29
8760	Aussteifung	29
8761	Aussteifung	29
8764	Aussteifung	29
8768	Aussteifung	29
8769	Aussteifung	29
8777	Aussteifung	29
8786	Aussteifung	29
8787	Aussteifung	29
8790	Aussteifung	29
8794	Aussteifung	29
8878	Bürstendichtung	31, 44, 47, 49

Systemdiagramm · System Chart

